

KENWOOD

Document Copyrights

Copyright 2006 by Kenwood Corporation. All rights reserved.

No part of this manual may be reproduced, translated, distributed, or transmitted in any form or by any means, electronic, mechanical, photocopying, recording, or otherwise, for any purpose without the prior written permission of Kenwood.

Disclaimer

While every precaution has been taken in the preparation of this manual, Kenwood assumes no responsibility for errors or omissions. Neither is any liability assumed for damages resulting from the use of the information contained herein. Kenwood reserves the right to make changes to any products herein at any time for improvement purposes.

TK-3140

SERVICE MANUAL

SUPPLEMENT

This TK-3140 service manual contains a number of sections which differ from the service manual (B51-8603-00) for the TK-3140. For items other than those in this TK-3140 service manual please refer to the service manual (B51-8603-00) for the TK-3140.

CONTENTS

GENERAL	2
SYSTEM SET-UP	2
SEMICONDUCTOR DATA	3
PARTS LIST	4
EXPLODED VIEW	12
ADJUSTMENT	13
PC BOARD VIEWS	
TX-RX UNIT (X57-6410-10)	21
SCHEMATIC DIAGRAM	31
BLOCK DIAGRAM	35
LEVEL DIAGRAM	37
KBP-5,KRA-23	38
SPECIFICATIONS	39



**Does not come with antenna.
Antenna is available as an option.**

TK-3140

GENERAL / SYSTEM SET-UP

INTRODUCTION

SCOPE OF THIS MANUAL

This manual is intended for use by experienced technicians familiar with similar types of commercial grade communications equipment. It contains all required service information for the equipment and is current as of the publication date. Changes which may occur after publication are covered by either Service Bulletins or Manual Revisions. These are issued as required.

ORDERING REPLACEMENT PARTS

When ordering replacement parts or equipment information, the full part identification number should be included. This applies to all parts : components, kits, or chassis. If the part number is not known, include the chassis or kit number of which it is a part, and a sufficient description of the required component for proper identification.

PERSONNEL SAFETY

The following precautions are recommended for personnel safety:

- DO NOT transmit until all RF connectors are verified secure and any open connectors are properly terminated.
- SHUT OFF and DO NOT operate this equipment near electrical blasting caps or in an explosive atmosphere.
- This equipment should be serviced by a qualified technician only.

SERVICE

This radio is designed for easy servicing. Refer to the schematic diagrams, printed circuit board views, and alignment procedures contained within.

SYSTEM SET-UP

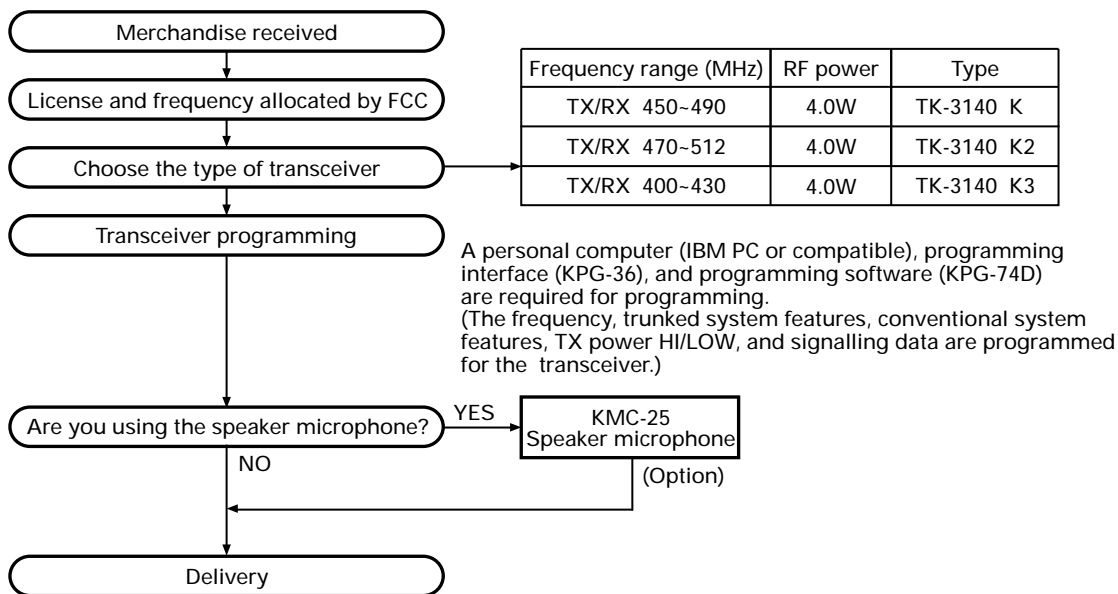

Frequency Configuration

The receiver is a double-conversion superheterodyne with a first intermediate frequency (IF) of 44.85MHz and a second IF of 455kHz. Incoming signals from the antenna are mixed with the local signal from the PLL to produce the first IF of 44.85MHz.

This is then mixed with the 44.395MHz second local oscillator output to produce the 455kHz second IF. This is detected to give the demodulated signal.

The transmit signal frequency is generated by the PLL VCO, and modulated by the signal from the microphone. It is then amplified and sent to the antenna.

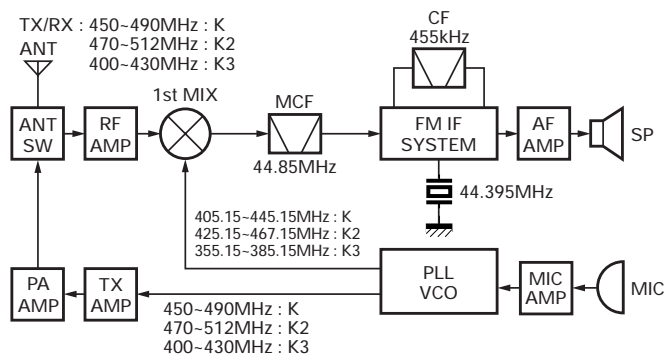

SEMICONDUCTOR DATA

Microprocessor : 30620M8A-XXXGP (TX-RX UNIT : IC309)

■ Pin function

Pin No.	Port Name	I/O	Function
1	LSDO	O	Low speed data output. (QT/DQT/LTR)
2	HSDO	O	High speed data output. (DTMF)
3	HSDI	I	High speed data input. (2Tone)
4	DSTB	O	D/A converter data strobe output.
5	5RC	O	RX power control. H: TX L: RX
6	BYTE	-	+5V.
7	CNV _{ss}	-	GND.
8	AFDAT	O	MODEM MSK encode data output.
9	AFRDT	I	MODEM MSK decode data input.
10	RESET	-	CPU reset.
11	XOUT	-	CPU clock.
12	VSS	-	GND.
13	XIN	-	CPU clock.
14	V _{cc}	-	+5V
15	-	-	NC
16	DTSTD	I	DTMF decoder data detect input.
17	AFTRD	I	MODEM MSK encode data output timing Pulse input.
18	AFRTM	I	MODEM MSK decode data Input timing pulse input.
19	EEPDAT	I/O	EEPROM data input/output.
20	BEEP	O	Beep output.
21	SKEY	I	[S] Key input.
22	AKEY	I	[A] Key input.
23	BKEY	I	[B] Key input.
24	CKEY	I	[C] Key input.
25	AUX	I	[AUX] Key input.
26	PTT	I	[PTT] Key input.
27	MONI (SW1)	I	[MON] Key input.
28	LAMP (SW2)	I	[LAMP] Key input.
29	AUXTXD	O	External serial interface (COM1) TDX1.
30	UL	I	PLL unlock detect input.
31	DTMDAT	I	DTMF decoder data input.
32	DTCLK	O	DTMF decoder clock output.
33	TXD	O	Serial interface (COM0) TXD0 (to MIC connector).
34	RXD	I	Serial interface (COM0) RXD0 (to MIC connector).
35	DAT	O	Common data output.
36	CLK	O	Common clock output.
37	RDY	-	Can not used.
38	ALE	-	Can not used.
39	HOLD	-	Can not used.
40	HLDA	-	Can not used.
41	BLCK	-	Can not used.
42	RD	O	Flash memory RD bus.
43	BHE	-	Can not used.
44	WR	O	Flash memory WR bus.
45	SAVE	O	Battery save output.
46	SELF	I	Self programming mode enable input.
47	CS/MODE	O	LCD driver chip select output.
48	CS0	O	Flash memory chip enable.
49	A19	-	Can not used.
50-59	A18~A9	-	Flash memory address bus.

Pin No.	Port Name	I/O	Function
60	V _{cc}	-	+5V
61	A8	O	Flash memory address bus.
62	VSS	-	GND.
63-70	A7~A0	O	Flash memory address bus.
71	INT	I	Voltage detector input.
72	EP	O	PLL IC Data Strobe output.
73	DP	O	PLL IC Data output.
74	CP	O	PLL IC Clock output.
75-78	EN4~1	I	Rotary SW input 4~1.
79-86	D7~D0	I	Flash memory data bus.
87	PF	I	SP-Mic PF switch input.
88	VOL	I	Volume level input.
89	BATT2	I	Battery distinction input.
90	BATT1	I	Battery voltage
91	ASQL	I	Squelch level input.
92	TEMP	I	Thermistor input.
93	RSSI	I	Received signal strength indicator input (RSSI).
94	AVSS	-	GND.
95	LSDI	I	Low speed data input (QT/DQT/LTR).
96	VREF	-	+5V
97	AVCC	-	+5V
98	SFTSTB1	O	Shift register data strobe output.
99	OE	O	Shift register output enable output.
100	AFSTB	O	MODEM data strobe output.

TK-3140

PARTS LIST

* New Parts. △ indicates safety critical components.
 Parts without **Parts No.** are not supplied.
 Les articles non mentionnés dans le **Parts No.** ne sont pas fournis.
 Teile ohne **Parts No.** werden nicht geliefert.

L: Scandinavia K: USA P: Canada
 Y: PX (Far East, Hawaii) T: England E: Europe
 Y: AAFES (Europe) X: Australia M: Other Areas

TK-3140 (Y50-5640-XX)

TX-RX UNIT (X57-6410-XX)

Ref. No.	Address	New parts	Parts No.	Description	Destination
TK-3140					
1	1B		A02-3653-04	CABINET ASSY	
2	3A		A10-4060-04	CHASSIS	
3	3B		B01-0688-03	ESCUTCHEON(BELT HOOK)	
	-		B09-0625-03	CAP ACCESSORY	
5	2B		B10-2700-02	FRONT GLASS	
6	1A		B38-0859-05	LCD ASSY	
	-		B62-1476-20	INSTRUCTION MANUAL ACCESSORY	
8	3A	*	B72-1966-04	MODEL NAME PLATE	K2
8	3A	*	B72-1967-04	MODEL NAME PLATE	K3
8	3A	*	B72-2064-14	MODEL NAME PLATE	K
9	3B		E04-0436-05	RF COAXIAL RECEPTACLE(SMA)	
10	3A		E23-1188-04	TERMINAL(ANTENNA)	
11	3B		E23-1189-04	TERMINAL(BATT-)	
12	3A		E37-0978-05	LEAD WIRE WITH CONNECTOR(SW2)	
13	3A		E37-1007-05	LEAD WIRE WITH CONNECTOR(PTT)	
14	3B		E58-0440-05	SQUARE SOCKET	
15	3A		E72-0413-03	BATT TERMINAL BLOCK	
16	2A		F10-2415-04	SHIELDING PLATE(CPU)	
17	1A		F10-2416-03	SHIELDING PLATE(LCD)	
18	2A		F10-2444-04	SHIELDING PLATE	
19	3A,3B		F15-1006-04	SHADE	
20	1B		G10-1280-04	FIBROUS SHEET(SPEAKER)	
21	3A		G11-4046-04	SHEET(PTT)	
22	2A		G11-4050-04	SHEET(TCXO)	
23	1A		G11-4089-04	SHEET(LCD)	
24	3A		G11-4090-04	SHEET(FINAL FET)	
25	1A		G11-4174-04	SHEET(LCD)	
26	3B		G11-4186-14	SHEET	
27	3B	*	G11-4187-04	SHEET(CHASSIS)	
28	1A,2A	*	G11-4188-04	SHEET	
29	1B	*	G11-4189-04	SHEET(CABINET)	
30	1A	*	G11-4190-04	SHEET(CABINET)	
31	3A		G13-1885-04	CUSHION(ANT,SUB PCB)	
32	3B		G53-1539-02	PACKING(TOP)	
33	2B		G53-1540-02	PACKING(4 KEYS)	
34	3A		G53-1547-04	PACKING(BATT TERMINAL)	
	-		H52-1816-02	ITEM CARTON CASE	
36	2A		J19-5430-03	HOLDER(VOL/ENC)	
37	2A		J21-8423-04	HARDWARE FIXTURE(SUB PCB)	
38	2A		J21-8424-04	HARDWARE FIXTURE(CHASSIS)	
39	3B	*	J21-8443-04	HARDWARE FIXTURE(PACKING)	
	-		J29-0688-05	BELT HOOK ACCESSORY	
41	1B		J30-1269-04	SPACER(VOL)	
42	2B		J82-0078-05	FPC(VOL/ENC)	
43	3B		J82-0079-05	FPC(UNIVERSAL)	
44	1A		K29-9131-03	KNOB(PTT)	
45	1A		K29-9132-03	KEY TOP(SW1,SW2)	
46	1B		K29-9133-03	KNOB(VOL)	
47	1B		K29-9134-03	KNOB(ENC)	

Ref. No.	Address	New parts	Parts No.	Description	Destination
	-		N08-0548-04	DRESSED SCREW ACCESSORY	
B	3B		N14-0569-04	CIRCULAR NUT	
C	3B		N30-2604-46	PAN HEAD MACHINE SCREW	
D	3A		N30-2608-46	PAN HEAD MACHINE SCREW	
E	3B		N30-3006-45	PAN HEAD MACHINE SCREW	
F	3B		N79-2035-46	PAN HEAD TAPTITE SCREW	
G	1A,2A		N83-2005-46	PAN HEAD TAPTITE SCREW	
48	2B		R31-0617-05	VARIABLE RESISTOR	
49	2B		S60-0415-05	ROTARY SWITCH	
SP	2B		T07-0732-05	SPEAKER ASSY	
50	2B		T91-0630-05	MIC ELEMENT ASSY	

TX-RX UNIT (X57-6410-XX)					
-10:TK-3140 K -11:TK-3140 K2 -12:TK-3140 K3					
D309			B30-2156-05	LED(RED)	
D310			B30-2157-05	LED(YELLOW)	
C1			CK73HB1H471K	CHIP C 470PF K	
C2			CK73HB1H102K	CHIP C 1000PF K	
C4			CC73HCH1H100D	CHIP C 10PF D	
C5			CK73HB1H471K	CHIP C 470PF K	
C8			CK73HB1H102K	CHIP C 1000PF K	
C9			CC73HCH1H100D	CHIP C 10PF D	
C10			CK73HB1H471K	CHIP C 470PF K	
C11			C92-0713-05	CHIP-TAN 10UF 6.3WV	
C12-14			CK73HB1H471K	CHIP C 470PF K	
C16			C92-0004-05	CHIP-TAN 1.0UF 16WV	K2,K3
C16			C92-0521-05	CHIP-TAN 0.47UF 20WV	K
C17,18			CK73HB1A104K	CHIP C 0.10UF K	
C19			CK73HB1H102K	CHIP C 1000PF K	
C20			CC73HCH1H050C	CHIP C 5.0PF C	
C22			CC73HCH1H030C	CHIP C 3.0PF C	
C23			CC73HCH1H050C	CHIP C 5.0PF C	
C24			C92-0001-05	CHIP-C 0.1UF 35WV	K
C25			CC73HCH1H100D	CHIP C 10PF D	
C27			CK73HB1H471K	CHIP C 470PF K	
C28			CC73HCH1H101J	CHIP C 100PF J	
C29			CK73HB1H102K	CHIP C 1000PF K	
C30			CC73HCH1H100D	CHIP C 10PF D	
C31			CC73HCH1H090D	CHIP C 9.0PF D	K2
C31			CC73HCH1H110J	CHIP C 11PF J	K
C31			CC73HCH1H120J	CHIP C 12PF J	K3
C32			CC73HCH1H040C	CHIP C 4.0PF C	K2
C32			CC73HCH1H060D	CHIP C 6.0PF D	K,K3
C33			CC73HCH1H100D	CHIP C 10PF D	K2
C33			CC73HCH1H110J	CHIP C 11PF J	K
C33			CC73HCH1H180J	CHIP C 18PF J	K3
C34			CC73HCH1H040C	CHIP C 4.0PF C	K2
C34			CC73HCH1H060D	CHIP C 6.0PF D	K,K3
C36			CC73GCH1H030B	CHIP C 3.0PF B	K2,K3
C36			CC73GCH1H040B	CHIP C 4.0PF B	K
C37			CC73GCH1H010B	CHIP C 1.0PF B	
C38			CC73GCH1H040B	CHIP C 4.0PF B	K2

PARTS LIST

TX-RX UNIT (X57-6410-XX)

Ref. No.	Address	New parts	Parts No.	Description	Destination	Ref. No.	Address	New parts	Parts No.	Description	Destination
C38			CC73GCH1H050B	CHIP C 5.0PF B	K,K3	C136			CK73HB1H471K	CHIP C 470PF K	
C39			CK73HB1H471K	CHIP C 470PF K		C137			CK73HB1C103K	CHIP C 0.010UF K	
C40			CC73GCH1H020B	CHIP C 2.0PF B		C139			CK73HB1H471K	CHIP C 470PF K	
C41			CC73GCH1H060B	CHIP C 6.0PF B		C143			CC73GCH1H070B	CHIP C 7.0PF B	K2
C42			CC73GCH1H030B	CHIP C 3.0PF B	K2	C143			CC73GCH1H100C	CHIP C 10PF C	K
C42			CC73GCH1H040B	CHIP C 4.0PF B	K,K3	C143			CC73GCH1H150G	CHIP C 15PF G	K3
C43			CC73GCH1H0R5B	CHIP C 0.5PF B		C144			CC73GCH1H060B	CHIP C 6.0PF B	K2
C44			CC73GCH1H050B	CHIP C 5.0PF B		C144			CC73GCH1H070B	CHIP C 7.0PF B	K
C45			CK73HB1H471K	CHIP C 470PF K		C144			CC73GCH1H080B	CHIP C 8.0PF B	K3
C46			CC73HCH1H101J	CHIP C 100PF J		C146			CC73GCH1H270J	CHIP C 27PF J	K,K3
C47			CC73GCH1H0R5B	CHIP C 0.5PF B		C146			CC73GCH1H390J	CHIP C 39PF J	K2
C48,49			CK73HB1H102K	CHIP C 1000PF K		C147			CK73HB1H471K	CHIP C 470PF K	
C50			C92-0712-05	CHIP-TAN 22UF 6.3WV		C148			CC73HCH1H050C	CHIP C 5.0PF C	
C51			CC73HCH1H070D	CHIP C 7.0PF D		C149			CC73HCH1H101J	CHIP C 100PF J	K
C52			CK73HB1H102K	CHIP C 1000PF K		C149			CK73HB1H471K	CHIP C 470PF K	K2,K3
C53			CC73HCH1H330J	CHIP C 33PF J		C150			CC73HCH1H020C	CHIP C 2.0PF C	K
C54-56			CK73HB1H471K	CHIP C 470PF K		C150			CC73HCH1H040C	CHIP C 4.0PF C	K2
C57			CC73HCH1H070D	CHIP C 7.0PF D		C150			CC73HCH1H070D	CHIP C 7.0PF D	K3
C58			CC73GCH1H010B	CHIP C 1.0PF B		C151			CC73HCH1H010C	CHIP C 1.0PF C	K3
C60			CK73HB1H102K	CHIP C 1000PF K		C151			CC73HCH1H1R5C	CHIP C 1.5PF C	K,K2
C64			CK73HB1H471K	CHIP C 470PF K		C152			CC73HCH1H040C	CHIP C 4.0PF C	K
C65			CC73HCH1H020C	CHIP C 2.0PF C	K3	C152			CC73HCH1H060D	CHIP C 6.0PF D	K2,K3
C65,66			CC73HCH1H010C	CHIP C 1.0PF C	K2	C153			CC73HCH1H020C	CHIP C 2.0PF C	K,K3
C65,66			CC73HCH1H020C	CHIP C 2.0PF C	K	C153			CC73HCH1H1R5B	CHIP C 1.5PF B	K2
C66			CC73HCH1H010C	CHIP C 1.0PF C	K3	C154			CC73HCH1H100D	CHIP C 10PF D	K2
C67			C92-0001-05	CHIP-C 0.1UF 35WV		C154			CC73HCH1H150J	CHIP C 15PF J	K,K3
C68			C92-0714-05	CHIP-TAN 4.7UF 6.3WV		C155			CC73HCH1H050C	CHIP C 5.0PF C	K
C100-102			CK73HB1H471K	CHIP C 470PF K		C155			CC73HCH1H070D	CHIP C 7.0PF D	K2
C103			CC73HCH1H070D	CHIP C 7.0PF D	K,K2	C155			CC73HCH1H080D	CHIP C 8.0PF D	K3
C103			CC73HCH1H090D	CHIP C 9.0PF D	K3	C156			CC73HCH1H010C	CHIP C 1.0PF C	K2
C104,105			CK73HB1H471K	CHIP C 470PF K		C156			CC73HCH1H020C	CHIP C 2.0PF C	K,K3
C106			CC73HCH1H060D	CHIP C 6.0PF D		C157			CC73HCH1H010C	CHIP C 1.0PF C	K
C108			CK73HB1A104K	CHIP C 0.10UF K		C157			CC73HCH1H020C	CHIP C 2.0PF C	K2
C109			CC73HCH1H050C	CHIP C 5.0PF C	K,K2	C157			CC73HCH1H040C	CHIP C 4.0PF C	K3
C109			CC73HCH1H080D	CHIP C 8.0PF D	K3	C158			CC73HCH1H0R5C	CHIP C 0.5PF C	K3
C110			CC73HCH1H130J	CHIP C 13PF J		C158			CC73HCH1H030C	CHIP C 3.0PF C	K,K2
C111			CK73HB1H471K	CHIP C 470PF K		C160			CK73HB1H102K	CHIP C 1000PF K	
C115			CK73HB1H471K	CHIP C 470PF K		C164			CC73GCH1H101J	CHIP C 100PF J	K3
C116			CC73HCH1H330J	CHIP C 33PF J		C164			CC73GCH1H330G	CHIP C 33PF G	K
C119			CC73GCH1H300G	CHIP C 30PF G	K	C164			CC73GCH1H680J	CHIP C 68PF J	K2
C119			CC73GCH1H330G	CHIP C 33PF G	K2	C200			CK73GB1A224K	CHIP C 0.22UF K	
C119			CC73GCH1H390J	CHIP C 39PF J	K3	C201			CK73HB1A104K	CHIP C 0.10UF K	
C122			CK73HB1H471K	CHIP C 470PF K		C202			CK73HB1H221K	CHIP C 220PF K	
C123			C92-0565-05	CHIP-TAN 6.8UF 10WV		C203-205			CK73HB1A104K	CHIP C 0.10UF K	
C124			CK73GB0J105K	CHIP C 1.0UF K		C206			CK73HB1C103K	CHIP C 0.010UF K	
C125			CK73HB1H102K	CHIP C 1000PF K		C207			CK73HB1H471K	CHIP C 470PF K	
C126,127			CK73HB1H471K	CHIP C 470PF K		C208,209			CK73HB1H221K	CHIP C 220PF K	
C128			CC73HCH1H101J	CHIP C 100PF J		C210			CK73HB1A104K	CHIP C 0.10UF K	
C129,130			CK73HB1H471K	CHIP C 470PF K		C211			CK73HB1H102K	CHIP C 1000PF K	
C131			CC73GCH1H270G	CHIP C 27PF G	K,K3	C212			CC73HCH1H220J	CHIP C 22PF J	
C131			CC73GCH1H300G	CHIP C 30PF G	K2	C213			CC73HCH1H100D	CHIP C 10PF D	
C132			CK73HB1C103K	CHIP C 0.010UF K		C214			CK73HB1A104K	CHIP C 0.10UF K	
C133		*	CK73GB1A105K	CHIP C 1.0UF K		C215			C92-0773-05	CHIP-TAN 15UF 6.3WV	
C134			CK73HB1A104K	CHIP C 0.10UF K		C216			CK73HB1A104K	CHIP C 0.10UF K	
C135			CC73GCH1H080B	CHIP C 8.0PF B	K2	C217			CK73HB1H221K	CHIP C 220PF K	
C135			CC73GCH1H200G	CHIP C 20PF G	K,K3	C218			CK73HB1A104K	CHIP C 0.10UF K	

K : TK-3140 K
K2 : TK-3140 K2

K3 : TK-3140 K3

PARTS LIST

TX-RX UNIT (X57-6410-XX)

Ref. No.	Address	New parts	Parts No.	Description	Destination	Ref. No.	Address	New parts	Parts No.	Description	Destination
C219			CK73HB1A333K	CHIP C 0.033UF K		C270			CC73HCH1H020C	CHIP C 2.0PF C	K2,K3
C220			CK73HB1A104K	CHIP C 0.10UF K		C270			CC73HCH1H030C	CHIP C 3.0PF C	K
C221			CC73HCH1H680J	CHIP C 68PF J		C274			CC73GCH1H030B	CHIP C 3.0PF B	K
C222			CK73HB1A104K	CHIP C 0.10UF K		C274			CC73GCH1H3R5B	CHIP C 3.5PF B	K2
C223			CK73HB1C103K	CHIP C 0.010UF K		C275			CC73HCH1H101J	CHIP C 100PF J	
C224			C92-0713-05	CHIP-TAN 10UF 6.3WV		C276			CK73HB1H471K	CHIP C 470PF K	
C225			CK73HB1C103K	CHIP C 0.010UF K		C277			CC73GCH1H030B	CHIP C 3.0PF B	K2
C227			CK73HB1A104K	CHIP C 0.10UF K		C277			CC73GCH1H2R5B	CHIP C 2.5PF B	K3
C228,229			CK73HB1C103K	CHIP C 0.010UF K		C277			CC73GCH1H3R5B	CHIP C 3.5PF B	K
C230			CC73HCH1H100D	CHIP C 10PF D		C278-280			CK73HB1A104K	CHIP C 0.10UF K	
C231			CK73HB1C103K	CHIP C 0.010UF K		C281			CK73HB1H471K	CHIP C 470PF K	
C232			CK73HB1H471K	CHIP C 470PF K		C282			CK73HB1H102K	CHIP C 1000PF K	
C233			CK73HB1C103K	CHIP C 0.010UF K		C283,284			CK73HB1A104K	CHIP C 0.10UF K	
C234			CK73HB1H471K	CHIP C 470PF K		C285			CC73GCH1H0R5B	CHIP C 0.5PF B	K
C235			CC73HCH1H040C	CHIP C 4.0PF C	K2	C285			CC73GCH1H020B	CHIP C 2.0PF B	K2
C235			CC73HCH1H060D	CHIP C 6.0PF D	K,K3	C286			CC73GCH1H050B	CHIP C 5.0PF B	K,K3
C236			CC73HCH1H010C	CHIP C 1.0PF C	K2	C286			CC73GCH1H4R5B	CHIP C 4.5PF B	K2
C236			CC73HCH1H020C	CHIP C 2.0PF C	K,K3	C288			CK73HB1H471K	CHIP C 470PF K	
C237			CC73HCH1H150J	CHIP C 15PF J		C289			CC73GCH1H010B	CHIP C 1.0PF B	K3
C238			CC73HCH1H070D	CHIP C 7.0PF D	K2	C289			CC73GCH1H020B	CHIP C 2.0PF B	K,K2
C238			CC73HCH1H100D	CHIP C 10PF D	K	C290			CC73GCH1H050B	CHIP C 5.0PF B	K3
C238			CC73HCH1H110J	CHIP C 11PF J	K3	C290			CC73GCH1H3R5B	CHIP C 3.5PF B	K,K2
C239			CK73HB1H471K	CHIP C 470PF K		C292			CC73HCH1H020C	CHIP C 2.0PF C	K2
C240			CC73HCH1HR75C	CHIP C 0.75PF C	K	C292			CC73HCH1H030C	CHIP C 3.0PF C	K
C240			CC73HCH1H010C	CHIP C 1.0PF C	K3	C292			CC73HCH1H1R5B	CHIP C 1.5PF B	K3
C240			CC73HCH1H020C	CHIP C 2.0PF C	K2	C293			CC73GCH1H010B	CHIP C 1.0PF B	K2
C241			CC73HCH1H040C	CHIP C 4.0PF C	K2	C293			CC73GCH1H020B	CHIP C 2.0PF B	K,K3
C241			CC73HCH1H070D	CHIP C 7.0PF D	K,K3	C294			CK73GB1H471K	CHIP C 470PF K	
C242			CK73HB1A104K	CHIP C 0.10UF K		C295			CK73HB1H471K	CHIP C 470PF K	
C243			CK73HB1H102K	CHIP C 1000PF K		C298			CK73HB1H471K	CHIP C 470PF K	
C244			CC73GCH1H030B	CHIP C 3.0PF B	K2	C300			C92-0713-05	CHIP-TAN 10UF 6.3WV	
C244			CC73GCH1H050B	CHIP C 5.0PF B	K	C301			CK73HB1H471K	CHIP C 470PF K	
C244			CC73GCH1H090B	CHIP C 9.0PF B	K3	C302			CK73HB1A104K	CHIP C 0.10UF K	
C245			CK73HB1H471K	CHIP C 470PF K		C303			CK73HB1A473K	CHIP C 0.047UF K	
C248			CC73HCH1H330J	CHIP C 33PF J		C304			CC73HCH1H330J	CHIP C 33PF J	
C249			CC73HCH1H020C	CHIP C 2.0PF C	K2,K3	C305			CK73HB1C103K	CHIP C 0.010UF K	
C249			CC73HCH1H030C	CHIP C 3.0PF C	K	C306-308			CK73HB1A104K	CHIP C 0.10UF K	
C250			CK73HB1H471K	CHIP C 470PF K		C309			CC73HCH1H101J	CHIP C 100PF J	
C251			CC73GCH1H020B	CHIP C 2.0PF B		C310			CK73HB1C103K	CHIP C 0.010UF K	
C252			CC73HCH1H330J	CHIP C 33PF J		C311			CC73HCH1H101J	CHIP C 100PF J	
C253			CK73HB1A104K	CHIP C 0.10UF K		C312			C92-0713-05	CHIP-TAN 10UF 6.3WV	
C255			CK73HB1A104K	CHIP C 0.10UF K		C313			CC73HCH1H101J	CHIP C 100PF J	
C256			CC73HCH1H330J	CHIP C 33PF J		C314			CK73HB1H471K	CHIP C 470PF K	
C257-260			CK73HB1H471K	CHIP C 470PF K		C315			C92-0713-05	CHIP-TAN 10UF 6.3WV	
C261			CC73GCH1H120G	CHIP C 12PF G	K3	C316			CK73HB1A333K	CHIP C 0.033UF K	
C261			CK73GB1H471K	CHIP C 470PF K	K,K2	C318			CK73HB1H221K	CHIP C 220PF K	
C263			CC73HCH1H180J	CHIP C 18PF J	K3	C319			CC73HCH1H121J	CHIP C 120PF J	
C263			CC73HCH1H330J	CHIP C 33PF J	K,K2	C320			CK73HB1A104K	CHIP C 0.10UF K	
C264			CK73HB1H471K	CHIP C 470PF K		C321			CK73HB1H271K	CHIP C 270PF K	
C266			CK73HB1H471K	CHIP C 470PF K		C322			CK73HB1C103K	CHIP C 0.010UF K	
C267			CC73GCH1H030B	CHIP C 3.0PF B	K,K3	C323			CK73HB1H222K	CHIP C 2200PF K	
C267			CC73GCH1H2R5B	CHIP C 2.5PF B	K2	C324			CK73HB1A104K	CHIP C 0.10UF K	
C268			CC73HCH1H330J	CHIP C 33PF J		C325			CK73HB1C123K	CHIP C 0.012UF K	
C269			CC73GCH1H030B	CHIP C 3.0PF B	K	C327			CK73GB1H103K	CHIP C 0.010UF K	
C269			CC73GCH1H050B	CHIP C 5.0PF B	K3	C328			CK73GB1C683K	CHIP C 0.068UF K	
C269			CC73GCH1H2R5B	CHIP C 2.5PF B	K2	C329			CK73GB0J105K	CHIP C 1.0UF K	

PARTS LIST

TX-RX UNIT (X57-6410-XX)

Ref. No.	Address	New parts	Parts No.	Description	Destination	Ref. No.	Address	New parts	Parts No.	Description	Destination
C330			CK73HB1A104K	CHIP C 0.10UF K		C512-514			CK73GB1H272J	CHIP C 2700PF J	
C331			CK73HB1C223K	CHIP C 0.022UF K		C515			CC73HCH1H030C	CHIP C 3.0PF C	
C332-335			CK73HB1C103K	CHIP C 0.010UF K		C516			CC73HCH1H151J	CHIP C 150PF J	
C336,337			CC73HCH1H270J	CHIP C 27PF J		C517			CK73HB1A104K	CHIP C 0.10UF K	
C338			CC73HCH1H160J	CHIP C 16PF J		C518			CK73HB1A333K	CHIP C 0.033UF K	
C339-342			CK73HB1C103K	CHIP C 0.010UF K		C519			CC73HCH1H030C	CHIP C 3.0PF C	
C344			C92-0713-05	CHIP-TAN 10UF 6.3WV		C520			CK73GB1H152J	CHIP C 1500PF J	
C345			CK73GB1A474K	CHIP C 0.47UF K		C521			C92-0713-05	CHIP-TAN 10UF 6.3WV	
C346,347			CC73HCH1H470J	CHIP C 47PF J		C522			CK73HB1A104K	CHIP C 0.10UF K	
C348			CK73GB1A474K	CHIP C 0.47UF K		C523,524			CK73HB1H102K	CHIP C 1000PF K	
C349			CK73HB1C153K	CHIP C 0.015UF K		C525			CK73HB1A104K	CHIP C 0.10UF K	
C350			C92-0647-05	CHIP-TAN 3.3UF 6.3WV		C526			CK73GB1H562J	CHIP C 5600PF J	
C351			CC73HCH1H470J	CHIP C 47PF J		C527,528			CK73HB1A104K	CHIP C 0.10UF K	
C352-354			CK73HB1A104K	CHIP C 0.10UF K		C529			CK73GB1H562J	CHIP C 5600PF J	
C355			C92-0628-05	CHIP-TAN 10UF 10WV		C530			CK73FB0J475K	CHIP C 4.7UF K	
C356			CC73HCH1H470J	CHIP C 47PF J		C531			CK73HB1C153K	CHIP C 0.015UF K	
C357,358			C92-0712-05	CHIP-TAN 22UF 6.3WV		C532			CK73HB1H561K	CHIP C 560PF K	
C359			CC73HCH1H470J	CHIP C 47PF J		C533			CK73HB1H102K	CHIP C 1000PF K	
C362			CC73HCH1H470J	CHIP C 47PF J		C534			CC73HCH1H560J	CHIP C 56PF J	
C364			CC73HCH1H470J	CHIP C 47PF J		C535			CK73HB1A104K	CHIP C 0.10UF K	
C369			CC73HCH1H101J	CHIP C 100PF J		C536,537			CK73FB0J475K	CHIP C 4.7UF K	
C371			CC73HCH1H470J	CHIP C 47PF J		C538			CK73HB1H471K	CHIP C 470PF K	
C375			CC73HCH1H470J	CHIP C 47PF J		C539,540			CK73HB1H102K	CHIP C 1000PF K	
C382			CK73HB1A104K	CHIP C 0.10UF K		C541			CK73GB1C563K	CHIP C 0.056UF K	
C383,384			CC73HCH1H470J	CHIP C 47PF J		C542,543			CK73HB1H102K	CHIP C 1000PF K	
C386			CC73HCH1H470J	CHIP C 47PF J		C554-557			CK73HB1H102K	CHIP C 1000PF K	
C388			CK73HB1H102K	CHIP C 1000PF K		C700			CC73GCH1H020B	CHIP C 2.0PF B	K3
C389			CC73HCH1H470J	CHIP C 47PF J		C710			CC73GCH1H2R5B	CHIP C 2.5PF B	K
C390			CK73HB1A104K	CHIP C 0.10UF K		C720			C92-0714-05	CHIP-TAN 4.7UF 6.3WV	
C391,392			CK73HB1C103K	CHIP C 0.010UF K		C730		*	CS77SJOJ2R2M	CHIP-TAN 2.2UF 6.3WV	
C394-398			CK73HB1A104K	CHIP C 0.10UF K		C730			C92-0800-05	CHIP-TAN 2.2UF 6.3WV	K
C399			CK73HB1C103K	CHIP C 0.010UF K		C731			CC73HCH1H101J	CHIP C 100PF J	
C400			CK73HB1H471K	CHIP C 470PF K		C740			CK73HB1A104K	CHIP C 0.10UF K	
C402-405			CK73HB1H102K	CHIP C 1000PF K		C741		*	C92-0802-05	TANTALUM CAPACITOR	K2,K3
C408			CK73HB1H102K	CHIP C 1000PF K		TC1,2			C05-0384-05	CERAMIC TRIMMER CAP(10PF)	
C410			CK73FB1A475K	CHIP C 4.7UF K		CN300			E40-6178-05	PIN ASSY SOCKET	
C411		*	CK73GB1A105K	CHIP C 1.0UF K		CN301,302			E40-5856-05	FLAT CABLE CONNECTOR	
C413			C92-0713-05	CHIP-TAN 10UFR 6.3WV		CN303-306			E40-5929-05	PIN ASSY	
C415			CC73HCH1H101J	CHIP C 100PF J		CN400			E40-5856-05	FLAT CABLE CONNECTOR	
C416			C92-0713-05	CHIP-TAN 10UF 6.3WV		CN500			E40-6179-05	PIN ASSY	
C417			CK73GB0J105K	CHIP C 1.0UF K		F400			F53-0190-05	FUSE	
C419			CK73HB1H102K	CHIP C 1000PF J		CD200			L79-1779-05	TUNING COIL	
C420			CC73HCH1H101J	CHIP C 100PF J		CF200			L72-0995-05	CERAMIC FILTER	
C421		*	CK73GB1A105K	CHIP C 1.0UF K	K	CF201			L72-0996-05	CERAMIC FILTER	
C422			CK73FB1C105K	CHIP C 1.0UF K		L1			L40-4795-85	SMALL FIXED INDUCTOR(4.7UH)	
C423			C92-0713-05	CHIP-TAN 10UF 6.3WV		L3,4			L92-0163-05	BEADS CORE	
C424			CC73HCH1H101J	CHIP C 100PF J		L5			L40-1275-92	SMALL FIXED INDUCTOR(12NH)	
C425			CK73HB1A104K	CHIP C 0.10UF K		L6			L40-1875-92	SMALL FIXED INDUCTOR(18NH)	
C426			CC73HCH1H101J	CHIP C 100PF J		L7			L92-0163-05	BEADS CORE	
C500			CK73GB1H122K	CHIP C 1200PF K		L8			L40-1085-92	SMALL FIXED INDUCTOR(100NH)	
C501,502			CK73HB1A104K	CHIP C 0.10UF K		L9			L92-0163-05	BEADS CORE	
C503,504			CK73HB1C103K	CHIP C 0.010UF K		L10-12			L40-1085-92	SMALL FIXED INDUCTOR(100NH)	
C506			CK73HB1A104K	CHIP C 0.10UF K		L15			L40-2278-67	SMALL FIXED INDUCTOR(22NH)	K,K2
C507			CK73HB1C103K	CHIP C 0.010UF K		L15			L40-2778-67	SMALL FIXED INDUCTOR(27NH)	K3
C508			CK73HB1A104K	CHIP C 0.10UF K		L16			L40-2778-67	SMALL FIXED INDUCTOR(27NH)	K,K2
C509-511			CK73GB1H562J	CHIP C 5600PF J		L16			L40-3378-67	SMALL FIXED INDUCTOR(33NH)	K3

K : TK-3140 K
K2 : TK-3140 K2

K3 : TK-3140 K3

PARTS LIST

TX-RX UNIT (X57-6410-XX)

Ref. No.	Address	New parts	Parts No.	Description	Destination	Ref. No.	Address	New parts	Parts No.	Description	Destination
L17,18			L41-2285-03	SMALL FIXED INDUCTOR		CP316			RK75HA1J473J	CHIP-COM 47K J 1/16W	
L19,20			L40-3391-86	SMALL FIXED INDUCTOR(3.3UH)		CP317-320			RK75HA1J102J	CHIP-COM 1.0K J 1/16W	
L21			L40-1875-92	SMALL FIXED INDUCTOR(18NH)	K2	CP322			RK75HA1J102J	CHIP-COM 1.0K J 1/16W	
L21			L40-2275-92	SMALL FIXED INDUCTOR(22NH)	K	CP323,324			RK75HA1J473J	CHIP-COM 47K J 1/16W	
L21			L40-2775-92	SMALL FIXED INDUCTOR(27NH)	K3	CP326,327			RK75HA1J473J	CHIP-COM 47K J 1/16W	
L22			L92-0163-05	BEADS CORE		CP400,401			RK75HA1J473J	CHIP-COM 47K J 1/16W	
L23			L40-2275-92	SMALL FIXED INDUCTOR(22NH)		CP500,501			RK75HA1J472J	CHIP-COM 4.7K J 1/16W	
L100			L40-1875-92	SMALL FIXED INDUCTOR(18NH)		R1			RK73HB1J101J	CHIP R 100 J 1/16W	
L101			L40-2275-92	SMALL FIXED INDUCTOR(22NH)		R3			RK73HB1J151J	CHIP R 150 J 1/16W	
L102			L92-0162-05	BEADS CORE		R4			RK73HB1J183J	CHIP R 18K J 1/16W	K
L103			L40-1575-54	SMALL FIXED INDUCTOR(15NH)		R4			RK73HB1J273J	CHIP R 27K J 1/16W	K2
L104			L92-0149-05	FERRITE CHIP		R4			RK73HB1J333J	CHIP R 33K J 1/16W	K3
L106			L34-4602-05	AIR-CORE COIL		R5			RK73HB1J153J	CHIP R 15K J 1/16W	K
L107			L92-0149-05	FERRITE CHIP		R5			RK73HB1J822J	CHIP R 8.2K J 1/16W	K2,K3
L108			L40-2285-54	SMALL FIXED INDUCTOR(220NH)		R6			RK73HB1J560J	CHIP R 56 J 1/16W	
L109			L34-4572-05	AIR-CORE COIL		R7			RK73HB1J222J	CHIP R 2.2K J 1/16W	K
L110-112			L34-4564-05	AIR-CORE COIL		R7			RK73HB1J681J	CHIP R 680 J 1/16W	K2
L113			L40-1092-81	SMALL FIXED INDUCTOR		R7,8			RK73HB1J102J	CHIP R 1.0K J 1/16W	K3
L114,115			L40-8265-57	SMALL FIXED INDUCTOR(8.2NH)		R8			RK73HB1J102J	CHIP R 1.0K J 1/16W	K,K2
L116			L40-1263-92	SMALL FIXED INDUCTOR(1.2NH)	K	R9			R92-1368-05	CHIP R 0 OHM	
L116			L40-1563-92	SMALL FIXED INDUCTOR(1.5NH)	K3	R10			RK73HB1J102J	CHIP R 1.0K J 1/16W	
L201			L40-1091-86	SMALL FIXED INDUCTOR(1.0UH)		R11			RK73HB1J154J	CHIP R 150K J 1/16W	
L202			L40-5681-86	SMALL FIXED INDUCTOR(0.56UH)		R13-15			RK73HB1J473J	CHIP R 47K J 1/16W	
L203			L92-0163-05	BEADS CORE		R16			RK73HB1J181J	CHIP R 180 J 1/16W	
L204			L40-1095-85	SMALL FIXED INDUCTOR(1.0UH)		R17			RK73HB1J101J	CHIP R 100 J 1/16W	
L205			L40-1875-57	SMALL FIXED INDUCTOR(18.0NH)	K	R18			RK73HB1J151J	CHIP R 150 J 1/16W	
L205,206			L40-1875-57	SMALL FIXED INDUCTOR(18.0NH)	K2,K3	R19			RK73HB1J101J	CHIP R 100 J 1/16W	
L206			L40-2275-57	SMALL FIXED INDUCTOR(22.0NH)	K	R20			RK73HB1J104J	CHIP R 100K J 1/16W	
L207			L40-2775-92	SMALL FIXED INDUCTOR(27NH)		R21			RK73HB1J154J	CHIP R 150K J 1/16W	
L209-211		*	L41-1078-14	SMALL FIXED INDUCTOR	K3	R22			RK73HB1J472J	CHIP R 4.7K J 1/16W	
L209-211			L41-8268-14	SMALL FIXED INDUCTOR	K,K2	R23			RK73HB1J101J	CHIP R 100 J 1/16W	
L212			L92-0163-05	BEADS CORE		R24			RK73HB1J102J	CHIP R 1.0K J 1/16W	
L213			L41-2285-03	SMALL FIXED INDUCTOR		R25			RK73HB1J682J	CHIP R 6.8K J 1/16W	
L215			L41-1278-14	SMALL FIXED INDUCTOR	K3	R26			RK73HB1J103J	CHIP R 10K J 1/16W	
L215			L41-8268-14	SMALL FIXED INDUCTOR	K,K2	R27			RK73HB1J331J	CHIP R 330 J 1/16W	
L217		*	L41-1078-14	SMALL FIXED INDUCTOR	K3	R28			RK73HH1J333D	CHIP R 33K D 1/16W	
L217		*	L41-6868-14	SMALL FIXED INDUCTOR	K2	R29			RK73HH1J104D	CHIP R 100K D 1/16W	
L217			L41-8268-14	SMALL FIXED INDUCTOR	K	R31			RK73HB1J470J	CHIP R 47 J 1/16W	
L219		*	L41-3978-03	SMALL FIXED INDUCTOR	K2	R32-35			R92-1368-05	CHIP R 0 OHM	
L219			L41-4778-03	SMALL FIXED INDUCTOR	K	R100,101			RK73HB1J472J	CHIP R 4.7K J 1/16W	
L300-313			L92-0163-05	BEADS CORE		R102			RK73HB1J473J	CHIP R 47K J 1/16W	
L314-317			L92-0408-05	FERRITE CHIP		R103			RK73HB1J331J	CHIP R 330 J 1/16W	
L320			L92-0163-05	BEADS CORE		R104			RK73HB1J220J	CHIP R 22 J 1/16W	
L400			L92-0149-05	FERRITE CHIP		R105			RK73HB1J681J	CHIP R 680 J 1/16W	
L500			L92-0163-05	BEADS CORE		R106			RK73HB1J152J	CHIP R 1.5K J 1/16W	
L710		*	L41-3369-16	SMALL FIXED INDUCTOR	K3	R107			RK73HB1J100J	CHIP R 10 J 1/16W	
L730			L92-0163-05	BEADS CORE		R108,109			RK73HB1J331J	CHIP R 330 J 1/16W	
X1			L77-1871-05	TCXO (16.8MHZ)		R111			RK73HB1J180J	CHIP R 18 J 1/16W	
X200			L77-1760-15	CRYSTAL RESONATOR(44.395MHZ)		R112			RK73HB1J331J	CHIP R 330 J 1/16W	
X300			L77-1810-05	CRYSTAL RESONATOR(9.8304MHZ)		R114			RK73HB1J104J	CHIP R 100K J 1/16W	K3
X500			L77-1708-05	CRYSTAL RESONATOR(3.579545MHZ)		R114			RK73HB1J124J	CHIP R 120K J 1/16W	K,K2
XF200			L71-0530-05	MCF (44.85MHZ)		R115			RK73HB1J473J	CHIP R 47K J 1/16W	K,K3
CP1,2			RK75HA1J102J	CHIP-COM 1.0K J 1/16W		R115			RK73HB1J683J	CHIP R 68K J 1/16W	K2
CP300-313			RK75HA1J102J	CHIP-COM 1.0K J 1/16W		R116			RK73HB1J220J	CHIP R 22 J 1/16W	
CP314			RK75HA1J473J	CHIP-COM 47K J 1/16W		R119,120			RK73EB2ER39K	CHIP R 0.39 K 1/4W	
CP315			RK75HA1J102J	CHIP-COM 1.0K J 1/16W		R121			RK73HB1J273J	CHIP R 27K J 1/16W	K3

PARTS LIST

TX-RX UNIT (X57-6410-XX)

Ref. No.	Address	New parts	Parts No.	Description	Destination	Ref. No.	Address	New parts	Parts No.	Description	Destination
R121			RK73HB1J473J	CHIP R 47K J 1/16W	K,K2	R239-241			RK73HB1J105J	CHIP R 1.0M J 1/16W	
R122			R92-0670-05	CHIP R 0 OHM		R243			RK73HB1J221J	CHIP R 220 J 1/16W	
R123			RK73EB2ER39K	CHIP R 0.39 K 1/4W		R244			RK73HB1J104J	CHIP R 100K J 1/16W	
R124			R92-1368-05	CHIP R 0 OHM		R246			RK73HB1J104J	CHIP R 100K J 1/16W	
R125			RK73GB1J101J	CHIP R 100 J 1/16W		R247			RK73HB1J683J	CHIP R 68K J 1/16W	
R126			RK73HB1J473J	CHIP R 47K J 1/16W	K,K3	R248,249			RK73HB1J105J	CHIP R 1.0M J 1/16W	
R126			RK73HB1J823J	CHIP R 82K J 1/16W	K2	R250			RK73HB1J102J	CHIP R 1.0K J 1/16W	
R127-129			RK73HH1J154D	CHIP R 150K D 1/16W		R252			RK73HB1J470J	CHIP R 47 J 1/16W	
R131-133			RK73HH1J154D	CHIP R 150K D 1/16W		R253			R92-1252-05	CHIP R 0 OHM J 1/16W	
R134			RK73HB1J103J	CHIP R 10K J 1/16W		R254			RK73HB1J470J	CHIP R 47 J 1/16W	
R136			RK73HB1J473J	CHIP R 47K J 1/16W		R255			RK73HH1J272D	CHIP R 2.7K D 1/16W	
R138			R92-1368-05	CHIP R 0 OHM		R256			RK73HB1J473J	CHIP R 47K J 1/16W	
R139			RK73HH1J105D	CHIP R 1M D 1/16W		R259			RK73HB1J473J	CHIP R 47K J 1/16W	
R140			RK73HB1J102J	CHIP R 1.0K J 1/16W		R260			RK73HB1J223J	CHIP R 22K J 1/16W	
R142,143			RK73HB1J104J	CHIP R 100K J 1/16W		R264			RK73HB1J181J	CHIP R 180 J 1/16W	
R144			R92-0670-05	CHIP R 0 OHM	K,K2	R265			RK73HB1J334J	CHIP R 330K J 1/16W	
R145,146			RK73HB1J271J	CHIP R 270 J 1/16W		R266			RK73HB1J272J	CHIP R 2.7K J 1/16W	
R147			R92-1252-05	CHIP R 0 OHM J 1/16W		R267			RK73HB1J334J	CHIP R 330K J 1/16W	
R149			R92-1368-05	CHIP R 0 OHM		R268			RK73HB1J221J	CHIP R 220 J 1/16W	
R151,152			R92-1368-05	CHIP R 0 OHM		R270			R92-0670-05	CHIP R 0 OHM	
R200			RK73HB1J224J	CHIP R 220K J 1/16W		R273			R92-1368-05	CHIP R 0 OHM	
R201			RK73HB1J104J	CHIP R 100K J 1/16W		R276			R92-1368-05	CHIP R 0 OHM	
R202			RK73HB1J153J	CHIP R 15K J 1/16W		R300			RK73HB1J154J	CHIP R 150K J 1/16W	
R203			RK73HH1J224D	CHIP R 220K D 1/16W		R301			RK73HB1J104J	CHIP R 100K J 1/16W	
R204			RK73HH1J824D	CHIP R 820K D 1/16W		R302			RK73HB1J393J	CHIP R 39K J 1/16W	
R205			RK73HB1J334J	CHIP R 330K J 1/16W		R303			RK73HB1J474J	CHIP R 470K J 1/16W	
R206			RK73HB1J333J	CHIP R 33K J 1/16W		R304			RK73HB1J394J	CHIP R 390K J 1/16W	
R207			RK73HB1J154J	CHIP R 150K J 1/16W		R305			RK73HB1J153J	CHIP R 15K J 1/16W	
R208			RK73HB1J472J	CHIP R 4.7K J 1/16W		R307			RK73HB1J103J	CHIP R 10K J 1/16W	
R209			RK73HB1J103J	CHIP R 10K J 1/16W		R308			RK73HB1J472J	CHIP R 4.7K J 1/16W	
R210			RK73HB1J123J	CHIP R 12K J 1/16W		R309			R92-1368-05	CHIP R 0 OHM	
R211			RK73HB1J223J	CHIP R 22K J 1/16W		R310			RK73HB1J473J	CHIP R 47K J 1/16W	
R212			RK73HB1J472J	CHIP R 4.7K J 1/16W		R311			RK73HB1J154J	CHIP R 150K J 1/16W	
R213			RK73HB1J123J	CHIP R 12K J 1/16W		R312			RK73HB1J104J	CHIP R 100K J 1/16W	
R214			RK73HB1J334J	CHIP R 330K J 1/16W		R313			RK73HB1J103J	CHIP R 10K J 1/16W	
R215			RK73HB1J332J	CHIP R 3.3K J 1/16W		R314			RK73HB1J474J	CHIP R 470K J 1/16W	
R216			RK73HB1J472J	CHIP R 4.7K J 1/16W		R315			RK73HB1J472J	CHIP R 4.7K J 1/16W	
R217			RK73HB1J334J	CHIP R 330K J 1/16W		R316			RK73HB1J104J	CHIP R 100K J 1/16W	
R218			RK73HB1J123J	CHIP R 12K J 1/16W		R317			RK73HB1J184J	CHIP R 180K J 1/16W	
R219			RK73HB1J224J	CHIP R 220K J 1/16W		R318			RK73HB1J104J	CHIP R 100K J 1/16W	
R220			RK73HB1J332J	CHIP R 3.3K J 1/16W		R319			RK73HB1J473J	CHIP R 47K J 1/16W	
R221		*	RK73HH1J332D	CHIP R 3.3K D 1/16W		R320			RK73HB1J563J	CHIP R 56K J 1/16W	
R222			RK73HB1J220J	CHIP R 22 J 1/16W		R321			RK73HB1J823J	CHIP R 82K J 1/16W	
R223			RK73HB1J184J	CHIP R 180K J 1/16W		R322			RK73HB1J154J	CHIP R 150K J 1/16W	
R226			RK73HB1J221J	CHIP R 220 J 1/16W		R323			RK73HB1J823J	CHIP R 82K J 1/16W	
R227,228			RK73HB1J331J	CHIP R 330 J 1/16W		R324,325			RK73HB1J334J	CHIP R 330K J 1/16W	
R229			RK73HB1J472J	CHIP R 4.7K J 1/16W		R326			R92-1368-05	CHIP R 0 OHM	
R230			R92-1368-05	CHIP R 0 OHM		R327			RK73HB1J473J	CHIP R 47K J 1/16W	
R231			R92-1252-05	CHIP R 0 OHM J 1/16W		R328			RK73HB1J104J	CHIP R 100K J 1/16W	
R232			RK73HB1J102J	CHIP R 1.0K J 1/16W		R329			RK73HB1J274J	CHIP R 270K J 1/16W	
R233			RK73HB1J151J	CHIP R 150 J 1/16W		R330			RK73HB1J184J	CHIP R 180K J 1/16W	
R234			RK73HB1J104J	CHIP R 100K J 1/16W		R331			RK73HB1J124J	CHIP R 120K J 1/16W	
R235			RK73HB1J563J	CHIP R 56K J 1/16W		R332			RK73HB1J474J	CHIP R 470K J 1/16W	
R236			RK73HB1J104J	CHIP R 100K J 1/16W		R333			RK73HB1J473J	CHIP R 47K J 1/16W	
R237			RK73HB1J563J	CHIP R 56K J 1/16W		R334			RK73HB1J184J	CHIP R 180K J 1/16W	
R238			R92-1368-05	CHIP R 0 OHM		R336-338			RK73HB1J223J	CHIP R 22K J 1/16W	

K : TK-3140 K
K2 : TK-3140 K2

K3 : TK-3140 K3

PARTS LIST

TX-RX UNIT (X57-6410-XX)

Ref. No.	Address	New parts	Parts No.	Description	Destination	Ref. No.	Address	New parts	Parts No.	Description	Destination
R339,341			RK73HB1J103J	CHIP R 10K J 1/16W		R413			RK73HB1J105J	CHIP R 1.0M J 1/16W	
R342			RK73HB1J223J	CHIP R 22K J 1/16W		R414			RK73HB1J103J	CHIP R 10K J 1/16W	
R343			RK73HB1J103J	CHIP R 10K J 1/16W		R500			R92-1368-05	CHIP R 0 OHM	
R344,345			R92-1368-05	CHIP R 0 OHM		R501			RK73HH1J913D	CHIP R 91K D 1/16W	
R346			RK73HB1J473J	CHIP R 47K J 1/16W		R502			RK73HH1J683D	CHIP R 68K D 1/16W	
R347			RK73HB1J102J	CHIP R 1.0K J 1/16W		R503			RK73HH1J333D	CHIP R 33K D 1/16W	
R348			RK73HB1J472J	CHIP R 4.7K J 1/16W		R504			RK73HH1J913D	CHIP R 91K D 1/16W	
R349,350			RK73HB1J473J	CHIP R 47K J 1/16W		R505			RK73HB1J564J	CHIP R 560K J 1/16W	
R351			R92-1368-05	CHIP R 0 OHM		R506			R92-1368-05	CHIP R 0 OHM	
R352,353			RK73HB1J102J	CHIP R 1.0K J 1/16W		R507			RK73HH1J274D	CHIP R 270K D 1/16W	
R354			R92-1368-05	CHIP R 0 OHM		R508			RK73HH1J913D	CHIP R 91K D 1/16W	
R356			RK73HB1J473J	CHIP R 47K J 1/16W		R509			R92-1368-05	CHIP R 0 OHM	
R357			RK73HB1J471J	CHIP R 470 J 1/16W		R510			RK73HH1J682D	CHIP R 6.8K D 1/16W	
R358			R92-1368-05	CHIP R 0 OHM		R511			RK73GB1J155J	CHIP R 1.5M J 1/16W	
R359			RK73HB1J153J	CHIP R 15K J 1/16W		R512			RK73HH1J683D	CHIP R 68K D 1/16W	
R360			RK73HB1J182J	CHIP R 1.8K J 1/16W		R513			RK73HB1J474J	CHIP R 470K J 1/16W	
R361			RK73GB1J102J	CHIP R 1.0K J 1/16W		R514			RK73HH1J682D	CHIP R 6.8K D 1/16W	
R362			RK73HB1J473J	CHIP R 47K J 1/16W		R515			RK73HB1J101J	CHIP R 100 J 1/16W	
R363			RK73HB1J124J	CHIP R 120K J 1/16W		R516			RK73HB1J184J	CHIP R 180K J 1/16W	
R364			RK73HB1J104J	CHIP R 100K J 1/16W		R517			RK73HB1J103J	CHIP R 10K J 1/16W	
R365			RK73HB1J473J	CHIP R 47K J 1/16W		R518			RK73HB1J223J	CHIP R 22K J 1/16W	
R366			RK73HB1J102J	CHIP R 1.0K J 1/16W		R519			RK73HB1J102J	CHIP R 1.0K J 1/16W	
R367			RK73HB1J103J	CHIP R 10K J 1/16W		R520			RK73HB1J472J	CHIP R 4.7K J 1/16W	
R368			RK73HB1J102J	CHIP R 1.0K J 1/16W		R521			RK73HB1J394J	CHIP R 390K J 1/16W	
R369			RK73HB1J563J	CHIP R 56K J 1/16W		R522			RK73HB1J333J	CHIP R 33K J 1/16W	
R370			RK73HB1J104J	CHIP R 100K J 1/16W		R523			RK73HB1J470J	CHIP R 47 J 1/16W	
R371			RK73HB1J272J	CHIP R 2.7K J 1/16W		R524			RK73HB1J224J	CHIP R 220K J 1/16W	
R372			R92-1368-05	CHIP R 0 OHM		R525			RK73HB1J184J	CHIP R 180K J 1/16W	
R373			RK73HB1J124J	CHIP R 120K J 1/16W		R526			RK73HB1J394J	CHIP R 390K J 1/16W	
R374			RK73HB1J104J	CHIP R 100K J 1/16W		R527			RK73HB1J224J	CHIP R 220K J 1/16W	
R376			RK73HB1J103J	CHIP R 10K J 1/16W		R528			RK73HB1J220J	CHIP R 22 J 1/16W	
R377			RK73HB1J104J	CHIP R 100K J 1/16W		R529			RK73HB1J473J	CHIP R 47K J 1/16W	
R378			RK73HB1J101J	CHIP R 100 J 1/16W		R530			RK73HB1J474J	CHIP R 470K J 1/16W	
R379			RK73HB1J821J	CHIP R 820 J 1/16W		R531			RK73HB1J184J	CHIP R 180K J 1/16W	
R380,381			RK73HB1J101J	CHIP R 100 J 1/16W		R532,533			RK73HB1J104J	CHIP R 100K J 1/16W	
R382			RK73HB1J103J	CHIP R 10K J 1/16W		R537			R92-1368-05	CHIP R 0 OHM	
R383			RK73HB1J101J	CHIP R 100 J 1/16W		R603-611			RK73HB1J471J	CHIP R 470 J 1/16W	
R384			RK73HB1J331J	CHIP R 330 J 1/16W		R612,613			R92-1368-05	CHIP R 0 OHM	
R385			RK73HB1J470J	CHIP R 47 J 1/16W		R614,615			RK73HB1J473J	CHIP R 47K J 1/16W	
R386			RK73HB1J331J	CHIP R 330 J 1/16W		R617,618			RK73HB1J473J	CHIP R 47K J 1/16W	
R388			RK73HB1J474J	CHIP R 470K J 1/16W		R619			R92-1368-05	CHIP R 0 OHM	
R389			RK73HB1J472J	CHIP R 4.7K J 1/16W		R620			RK73HB1J473J	CHIP R 47K J 1/16W	
R390			RK73HB1J821J	CHIP R 820 J 1/16W		R621			R92-1368-05	CHIP R 0 OHM	
R391,392			RK73HB1J331J	CHIP R 330 J 1/16W		R623			R92-1368-05	CHIP R 0 OHM	
R393			R92-1368-05	CHIP R 0 OHM		R701			R92-1368-05	CHIP R 0 OHM	K2,K3
R397,398			R92-1368-05	CHIP R 0 OHM		R710			R92-1252-05	CHIP R 0 OHM J 1/16W	K2
R400			RK73HB1J103J	CHIP R 10K J 1/16W		R740			RK73HB1J473J	CHIP R 47K J 1/16W	
R401,402			RK73HH1J474D	CHIP R 470K D 1/16W		S600-602			S70-0457-05	TACT SWITCH	
R403			RK73HB1J334J	CHIP R 330K J 1/16W		D1-4			HVC376B	VARIABLE CAPACITANCE DIODE	
R404			RK73HB1J105J	CHIP R 1.0M J 1/16W		D5			1SV278	VARIABLE CAPACITANCE DIODE	
R405			R92-1252-05	CHIP R 0 OHM J 1/16W		D6			MA2S111	DIODE	
R406			RK73HB1J103J	CHIP R 10K J 1/16W		D7-10			HVC376B	VARIABLE CAPACITANCE DIODE	
R407			RK73HB1J224J	CHIP R 220K J 1/16W		D100,101			HSC277	DIODE	
R408			RK73HB1J472J	CHIP R 4.7K J 1/16W		D102-105			HVC131	DIODE	
R409			RK73HB1J473J	CHIP R 47K J 1/16W		D106			HZU5CLL	ZENER DIODE	
R410,411			R92-1368-05	CHIP R 0 OHM							

PARTS LIST

TX-RX UNIT (X57-6410-XX)

Ref. No.	Address	New parts	Parts No.	Description	Destination	Ref. No.	Address	New parts	Parts No.	Description	Destination
D200			HVC131	DIODE		Q203			2SK1824	FET	
D201			RB706F-40	DIODE		Q204			2SK1830	FET	
D202,203			DAN235E	DIODE		Q205			2SC4649(N,P)	TRANSISTOR	
D204-208			HVC369B	VARIABLE CAPACITANCE DIODE		Q206,207			3SK318	FET	
D209			MA2S111	DIODE		Q208			2SC4617(S)	TRANSISTOR	
D300			RB706F-40	DIODE		Q300			2SC4649(N,P)	TRANSISTOR	
D301			1SS373	DIODE		Q301			2SJ347	FET	
D302			DA221	DIODE		Q302			2SC4617(S)	TRANSISTOR	
D303,304			015AZ6.8	ZENER DIODE		Q303			2SB1132(Q,R)	TRANSISTOR	
D305			015AZ2.4-X	ZENER DIODE		Q304			2SC4617(S)	TRANSISTOR	
D306			DA221	DIODE		Q305			UPA672T	FET	
D307			015AZ6.8	ZENER DIODE		Q306			2SC4617(S)	TRANSISTOR	
D308			NNC06.8G	ZENER DIODE		Q307			UPA672T	FET	
D402			1SR154-400	DIODE		Q308			2SK1824	FET	
D403			MA2S111	DIODE		Q309,310			2SC4617(S)	TRANSISTOR	
D405			RB521S-30	DIODE		Q311			2SA1362(Y)	TRANSISTOR	
D501			RB706F-40	DIODE		Q400			2SJ347	FET	
IC1			SA7025DK	MOS IC		Q401			2SK1830	FET	
IC100			TA75W01FU	MOS IC		Q403			DTC144EE	DIGITAL TRANSISTOR	
IC200			TA31136FN	MOS IC		Q404			2SJ347	FET	
IC201			TC75W51FU	MOS IC		Q405			KTA2015(Y)	TRANSISTOR	
IC300			TC75W51FU	MOS IC		Q406			2SJ347	FET	
IC301			LC73872M	MOS IC		Q500			DTC144EE	DIGITAL TRANSISTOR	
IC302,303			TC75W51FU	MOS IC		Q501			UPA672T	FET	
IC304			TC75S51F	MOS IC		Q502			2SK1830	FET	
IC305,306			TC75W51FU	MOS IC		TH1			ERTJ0EV104H	THERMISTOR	
IC307			M62364FP	MOS IC		TH200			ERTJ0EV104H	THERMISTOR	
IC308			AT29C020-90T1	ROM IC		TH300			TN10-3S154JT	THERMISTOR	
IC308			W29C020C90	SRAM IC							
IC309			30620M8A-2N3GP	MPU							
IC310			AT2416N10SI2.5	ROM IC							
IC311,312			BU4094BCFV	MOS IC							
IC313			TDA7053AT	BI-POLAR IC							
IC400			XC61CN4202NR	MOS IC							
IC401		*	XC6204B502MR	MOS IC							
IC402			XC62GR5012PR	MOS IC							
IC403		*	XC6204B502MR	MOS IC							
IC404			XC61CN5002NR	MOS IC							
IC500			TC35453F	MOS IC							
IC501			TC75W51FU	MOS IC							
Q1			2SC5108(Y)	TRANSISTOR							
Q2,3			2SK508NV(K52)	FET							
Q4			2SJ347	FET							
Q5			2SC5108(Y)	TRANSISTOR							
Q6			RN47A4	TRANSISTOR							
Q7			2SC4617(S)	TRANSISTOR							
Q8			2SC5108(Y)	TRANSISTOR							
Q100			2SC5108(Y)	TRANSISTOR							
Q101			2SC5192	TRANSISTOR							
Q103			2SK2596	FET							
Q104,105			DTC114EE	DIGITAL TRANSISTOR							
Q106			2SK3476	FET							
Q107			2SK1824	FET							
Q108			DTA144EE	DIGITAL TRANSISTOR							
Q201			DTC144EE	DIGITAL TRANSISTOR							
Q202			RN47A4	TRANSISTOR							

EXPLODED VIEW

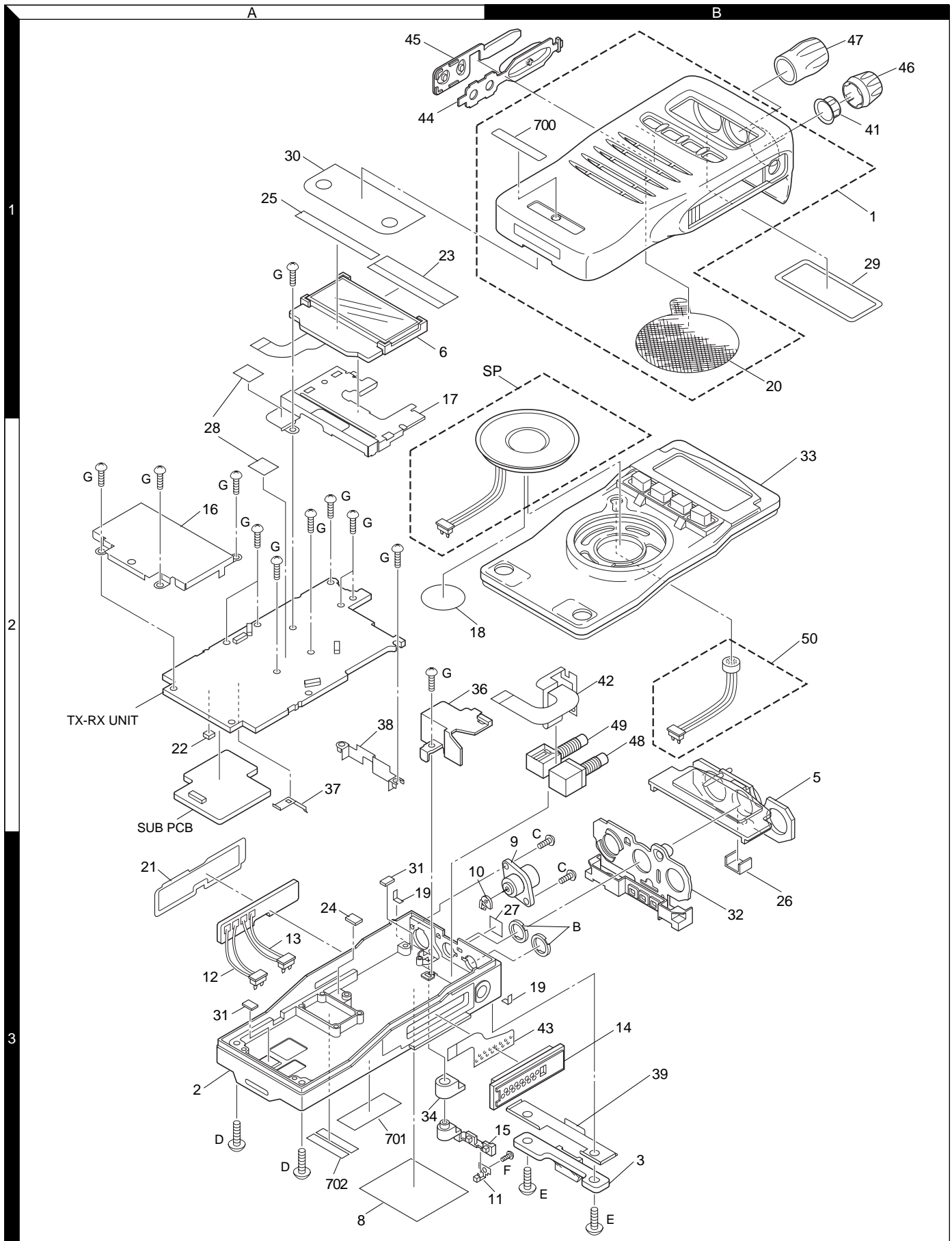

ADJUSTMENT

Test Mode

■ Test mode operating features



This transceiver has a test mode. **To enter test mode, press [A] key and turn power on. Hold [A] key until test channel No. and test signalling No. appears on LCD.** Test mode can be inhibited by programming. To exit test mode, switch the power on again. The following functions are available in test mode.

• Controls

Controls	"FCN" appears	"FCN" not appears
[PTT]	Used when making a transmission.	Used when making a transmission.
[AUX]	Unused	Unused
[MON] (SW1)	Monitor ON and OFF.	Monitor ON and OFF.
[LAMP] (SW2)	Lights the lamp for five seconds. Lighting is extended for a further five seconds by pressing any key while the lamp is lit.	Changes wide and narrow.
[S]	Sets to the Tuning mode.	Sets to the Tuning mode.
[A]	Function OFF	Function ON.
[B]	Compander function ON and OFF.	RF power HIGH and LOW.
[C]	Beat shift ON and OFF	Changes signalling.
[O] to [9], and [#],[*]	Used as the DTMF keypad. If a key is pressed during transmission, the DTMF corresponding to the key that was pressed is sent. (keypad model)	Used as the DTMF keypad. If a key is pressed during transmission, the DTMF corresponding to the key that was pressed is sent. (keypad model)
[ENCODER]	Changes channel.	Changes channel.

Note: If a [S],[A],[B],[C] key is pressed during transmission, the DTMF corresponding to the key that was pressed is sent.

• LCD indicator

"SCN"	Unused
" 	Lights at Compander ON.
"LO"	Lights at RF Power Low.
"P"	Unused
"MON"	Lights at monitor ON.
"SVC"	Unused
" 	Unused

• LED indicator

Red LED	Lights during transmission. Blinks at the low battery voltage warning.
Green LED	Lights when there is a carrier.

• Sub LCD indicator

"FCN"	appears at Function ON.
"n"	appears at Narrow ON.

■ Frequency and signalling

The set has been adjusted for the frequencies shown in the following table. When required, re-adjust them following the adjustment procedure to obtain the frequencies you want in actual operation.

Frequency (MHz)

Channel No.	K	
	RX (MHz)	TX (MHz)
1	470.05	470.10
2	450.05	450.10
3	489.95	489.90
4	470.00	470.00
5	470.20	470.20
6	470.40	470.40
7~16	—	—

Channel No.	K2	
	RX (MHz)	TX (MHz)
1	491.05	491.10
2	470.05	470.10
3	511.95	511.90
4	491.00	491.00
5	491.20	491.20
6	491.40	491.40
7~16	—	—

Channel No.	K3	
	RX (MHz)	TX (MHz)
1	415.05	415.10
2	400.05	400.10
3	429.95	429.90
4	415.00	415.00
5	415.20	415.20
6	415.40	415.40
7~16	—	—

ADJUSTMENT

Signalling

Signalling No.	RX	TX
1	None	None
2	None	100Hz square
3	LTR data	LTR data
4	QT 67.0Hz	QT 67.0Hz
5	QT 151.4Hz	QT 151.4Hz
6	QT 210.7Hz	QT 210.7Hz
7	QT 250.3Hz	QT 250.3Hz
8	DQT D023N	DQT D023N
9	DQT D754I	DQT D754I
10	DTMF DEC, (159D)	DTMF ENC, (159D)
11	None	DTMF tone 9
12	2 tone 321.7/928.1Hz	None
13	Single tone 1200Hz	Single tone 1200Hz
14	None	MSK
15	MSK code	MSK code

- **Preparations for tuning the transceiver**

Before attempting to tune the transceiver, connect the unit to a suitable power supply.

Whenever the transmitter is turned, the unit must be connected to a suitable dummy load (i.e. power meter).

The speaker output connector must be terminated with a 16Ω dummy load and connected to an AC voltmeter and an audio distortion meter or a SINAD measurement meter at all times during tuning.

- **Transceiver tuning**

(To place transceiver in tuning mode)

Channel appears on LCD. Set channel according to tuning requirements.

LCD display (Test mode)

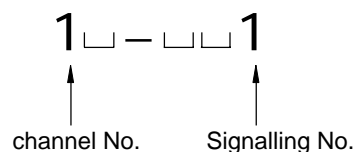

Press [S], now in tuning mode. Use [◀ B] button to write tuning data through tuning modes, and channel selector knob to adjust tuning requirements (1 to 256 appears on LCD).

Use [C ▶] button to select the adjustment item through tuning modes. Use [A] button to adjust 3 or 5 point tuning, and use [LAMP] button to switch between Wide/Narrow.

LCD display (Tuning mode)



Panel Tuning Mode frequency table

TEST Ch	K	
	RX frequency (MHz)	TX frequency (MHz)
L	440.05	440.10
L2	450.05	450.10
C	470.05	470.10
H2	480.05	480.10
H	489.95	489.90

TEST Ch	K2	
	RX frequency (MHz)	TX frequency (MHz)
L	470.05	470.10
L2	480.05	480.10
C	490.05	490.10
H2	510.05	510.10
H	519.95	519.90

TEST Ch	K3	
	RX frequency (MHz)	TX frequency (MHz)
L	400.05	400.10
L2	415.05	415.10
C	430.05	430.10
H2	440.05	440.10
H	449.95	449.90

ADJUSTMENT

■ Panel Tuning Mode flow chart

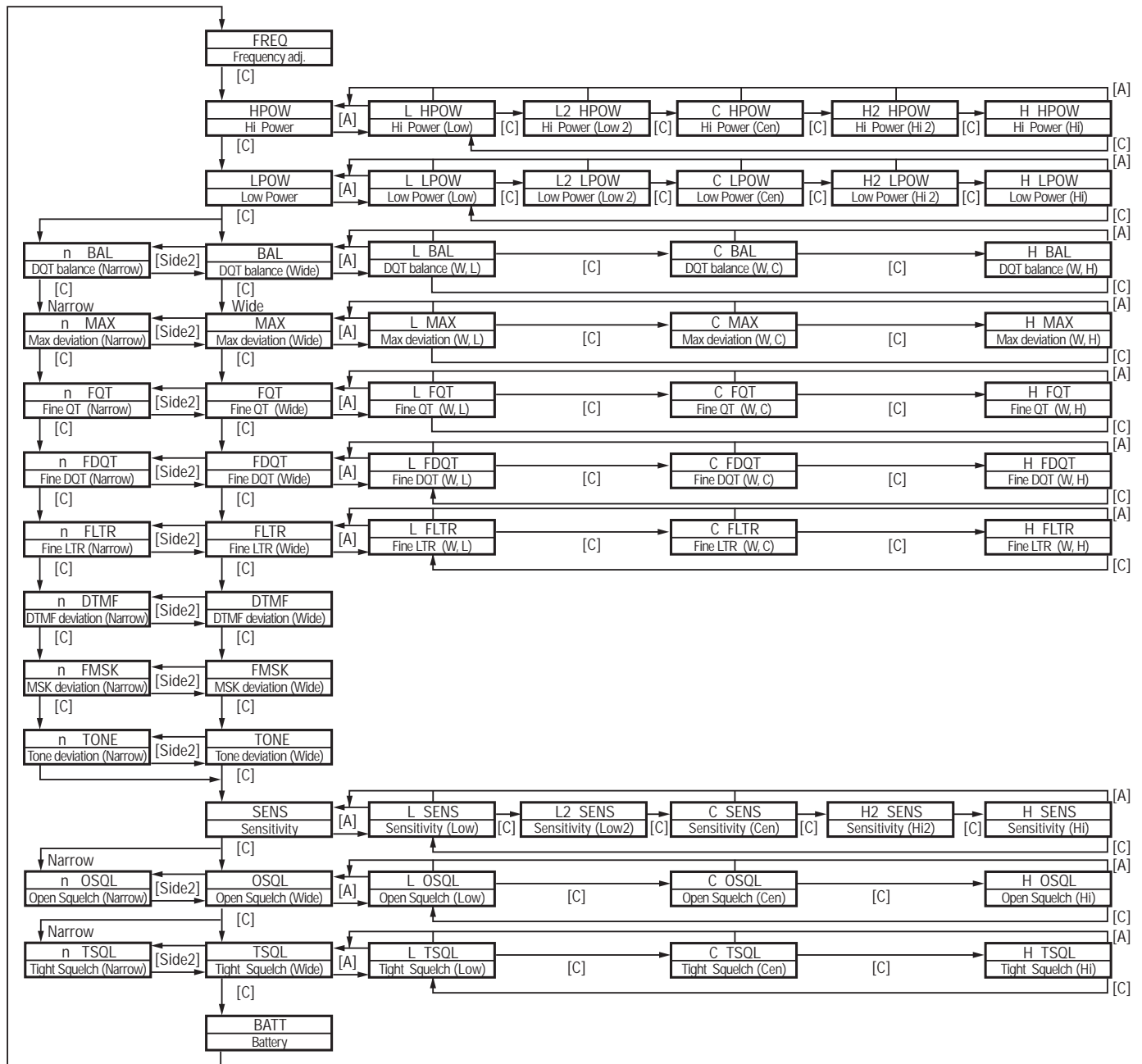

ADJUSTMENT

Common Section

Item	Condition	Measurement			Adjustment			Specifications/ Remark
		Test equipment	Unit	Terminal	Unit	Parts	Method	
1. Setting	1) BATT terminal voltage:7.5V 2) SSG Standard modulation [Wide] MOD:1kHz, DEV:3kHz [Narrow] MOD:1kHz, DEV:1.5kHz							
2. VCO lock voltage RX TX	[Panel Test Mode] 1) CH-Sig:2-1	Power meter DVM	Panel TX-RX	ANT CV	TX-RX	TC2	4.1V:K 4.2V:K2,K3	±0.1V
	2) CH-Sig:3-1						Check	0.6V or more
	3) CH-Sig:2-1 PTT:ON	TC1	4.1V:K 4.2V:K2,K3	±0.1V				
	4) CH-Sig:3-1 PTT:ON		Check	0.6V or more				

Transmitter Section

Item	Condition	Measurement			Adjustment			Specifications/ Remark
		Test equipment	Unit	Terminal	Unit	Parts	Method	
1. Frequency Adjust	1) Adj item [FREQ] Adjust [***] PTT:ON	Power meter Am meter	Panel	ANT	Panel	Encoder knob	Center frequency ± 100Hz	
2. Hight Power Adjust	1) Adj item [HPOW] Adjust [***] 2) Adj item [L HPOW] → [L2 HPOW] → [C HPOW] → [H2 HPOW] → [H HPOW] Adjust [***] PTT:ON					Encoder knob	4.0W	±0.1W 1.9A or less
Note: For K2 and K3 type; The output power 4.0W ±0.1W cannot be obtained by adjusting [H HPOW] value, set the same value as [H2 HPOW].								
3. Hight Power Check	[Panel Test Mode] 1) CH-Sig:1-1 PTT:ON 2) CH-Sig:2-1 PTT:ON 3) CH-Sig:3-1 PTT:ON						Check	3.7~4.3W 1.9A or less
4. Low Power Adjust	1) Adj item [LPOW] Adjust [***] 2) Adj item [L LPOW] → [L2 LPOW] → [C LPOW] → [H2 LPOW] → [H LPOW] Adjust [***] PTT:ON				Panel	Encoder knob	1.0W	±0.05W 1.0A or less
5. Low Power Check	[Panel Test Mode] 1) CH-Sig:1-1 Set low power (Push [B]) PTT:ON 2) CH-Sig:2-1 PTT:ON 3) CH-Sig:3-1 PTT:ON						Check	0.5~1.5W 1.2A or less

ADJUSTMENT

Item	Condition	Measurement			Adjustment			Specifications/ Remark
		Test equipment	Unit	Terminal	Unit	Parts	Method	
6. DQT Balance Adjust [Wide]	1) Adj item [BAL] Adjust [***] LPF:3kHz HPF:OFF	Power meter Dev meter Oscilloscope AG AF VTVM	Panel	ANT Universal connector	Panel	Encoder knob	Make the demodulation waves into square waves.	
	2) Adj item [L BAL] → [C BAL] → [H BAL] Adjust [***] PTT:ON							
[Narrow]	3) Adj item [n BAL] Adjust [***] PTT:ON							
7. Max DEV Adjust [Wide]	1) Adj item [MAX] Adjust [***] AG:1kHz / 150mV Dev meter filter LPF:15kHz HPF:OFF						3.8kHz (According to the larger +,-)	±50Hz
	2) Adj item [L MAX] → [C MAX] → [H MAX] Adjust [***] PTT:ON							
[Narrow]	1) Adj item [n MAX] Adjust [***] PTT:ON						1.75kHz (According to the larger+,-)	
8. MIC Sensitivity Check	[Panel Test Mode] 1) CH-Sig:1-1 AG:1kHz / Wide:15mV Narrow:16mV LPF:15kHz PTT:ON						Check	Wide:2.4~3.6kHz Narrow:1.0~2.2kHz
9. QT Deviation Adjust [Wide]	1) Adj item [FQT] Adjust [***] LPF:3kHz HPF:OFF	Power meter Dev meter Oscilloscope AG AF VTVM	Panel	ANT Universal connector	Panel	Encoder knob	Wide:0.75kHz Narrow:0.35kHz	±50Hz
	2) Adj item [L FQT] → [C FQT] → [H FQT] Adjust [***] PTT:ON							
[Narrow]	3) Adj item [n FQT] Adjust [***] PTT:ON							
10.DQT Deviation Adjust [Wide]	1) Adj item [FDQT] Adjust [***] LPF:3kHz HPF:OFF							
	2) Adj item [L FDQT] → [C FDQT] → [H FDQT] Adjust [***] PTT:ON							
[Narrow]	3) Adj item [n FDQT] Adjust [***] PTT:ON							

ADJUSTMENT

Item	Condition	Measurement			Adjustment			Specifications/ Remark
		Test equipment	Unit	Terminal	Unit	Parts	Method	
11.LTR Deviation Adjust [Wide]	1) Adj item [FLTR] Adjust [***] LPF:3kHz HPF:OFF	Power meter Dev meter Oscilloscope AG AF VTVM	Panel	ANT Universal connector	Panel	Encoder knob	1.0kHz	±0.1kHz
	2) Adj item [L FLTR] → [C FLTR] → [H FLTR] Adjust [***] PTT:ON						0.75kHz	±50Hz
12.DTMF Deviation Adjust [Wide]	3) Adj item [n FLTR] Adjust [***] PTT:ON						Wide:2.5kHz Narrow:1.25kHz	±0.1kHz
	1) Adj item [DTMF] Adjust [***] LPF:15kHz HPF:OFF PTT:ON							
13.MSK Deviation Adjust [Wide]	2) Adj item [n DTMF] Adjust [***] PTT:ON							
	1) Adj item [FMSK] Adjust [***] LPF:15kHz HPF:OFF PTT:ON						Wide:1.0kHz Narrow:0.75kHz	±0.1kHz
14.TONE Deviation Adjust [Wide]	2) Adj item [n FMSK] Adjust [***] PTT:ON							
	1) Adj item [TONE] Adjust [***] LPF:15kHz HPF:OFF PTT:ON						Wide:3.0kHz Narrow:1.5kHz	±0.1kHz
15.BATT Detection Writing	2) Adj item [n TONE] Adjust [***] PTT:ON							
	1) Adj item [BATT] Adjust [***] PTT:ON	Power meter DVM	Panel	ANT BATT terminal	Panel	Encoder knob	After pressing the PTT switch, confirm that one predeter- mined numeric in the range 1 to 256 appears and then press [B] key. That numeric will be stored in memory.	BATT terminal voltage:6.2V
16.BATT Detection Check	[Panel Test Mode] 1) CH-Sig:1-1 BATT terminal voltage: NiCd, NiMH:6.5V Li-ion:6.8V PTT:ON						Check	No blinking of LED
	2) BATT terminal voltage: NiCd, NiMH:5.7V Li-ion:6.0V PTT:ON							Blinking of LED

ADJUSTMENT

Receiver Section

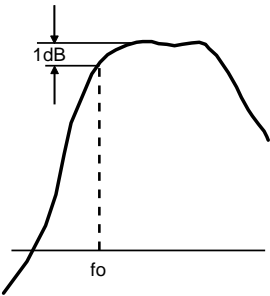
Item	Condition	Measurement			Adjustment			Specifications/ Remark
		Test equipment	Unit	Terminal	Unit	Parts	Method	
1. Sensitivity Adjust (BPF characteristic)	1) Adj item [SENS] Adjust [***] 2) Low-edge frequency Adj item [L SENS]→[L2 SENS]→ [C SENS]→[H2 SENS]→ [H SENS] Spe-Ana setting Center-f : 450MHz(K) Span : 100MHz RBW : 100kHz VBW : 1kHz REF level : -50dBm ATT : 0dB Tra-G setting Input level:-30dBm	Tracking generator Spectrum analyzer	Panel TX-RX	ANT BPF Need couple capacitor (1000PF)	Panel	Encoder knob	Adjustment Turn a knob and make "fo" level 1dB above from peak level. Caution Adjustment "SENS" value 60  fo=f L, f L2, f C, f H2, f H Adjust point frequency Refer to the Panel Tuning Mode frequency table on page 14.	
2. Sensitivity Check	[Panel Test Mode] 1) CH-Sig:1-1 SSG OUT Wide:-117dBm (MOD:1kHz / ±3kHz) Narrow:-116dBm (MOD:1kHz / ±1.5kHz)	SSG AF VTVM Oscilloscope	Panel	ANT Universal connector			Check	12dB SINAD or more
3. Squelch Adjust (Open)	1) Adj item [O SQL] Adjust [***] 2) Adj item [L OSQL] → [C OSQL] → [H OSQL] Adjust [***] SSG OUT: 12dB SINAD level 3) Adj item [n OSQL] Adjust [***] SSG OUT: 12dB SINAD level				Encoder knob squelch.	Adjust to point of opening		
4. Squelch Check (Open)	[Panel Test Mode] 1) CH-Sig:1-1 SSG OUT: 12dB SINAD level 2) SSG OUT:OFF					Check	Squelch must be opened. Squelch must be closed.	

ADJUSTMENT

Item	Condition	Measurement			Adjustment			Specifications/ Remark
		Test equipment	Unit	Terminal	Unit	Parts	Method	
5. Squelch Adjust	1) Adj item [T SQL] Adjust [***] 2) Adj item [L TSQL] → [C TSQL] → [H TSQL] Adjust [***] SSG OUT: 12dB SINAD level+5dB	SSG AF VTVM Oscilloscope	Panel	ANT Universal connector		Encoder knob	Adjust to point of opening squelch.	
	3) Adj item [n TSQL] Adjust [***] SSG OUT: 12dB SINAD level+5dB							
6. Squelch Check (Tight)	[Panel Test Mode] 1) CH-Sig:1-1 SSG OUT: 12dB SINAD level+8dB					Check	Squelch must be opened.	
	2) SSG OUT:OFF						Squelch must be closed.	

**Adjustment points
TX-RX unit (X57-6410-10)
component side view**

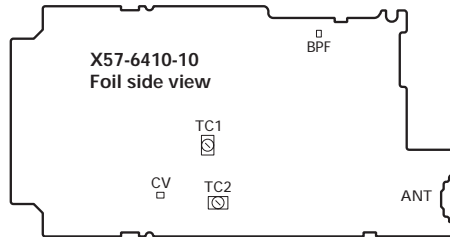

Band Pass Filter Characteristic (K)

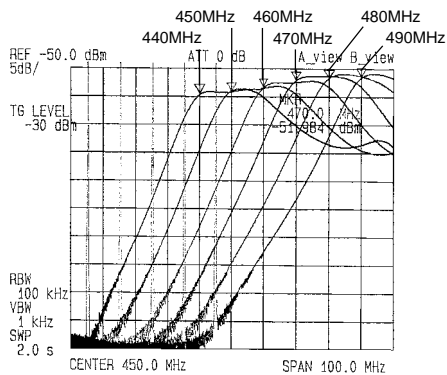

Band Pass Filter Characteristic (K2)

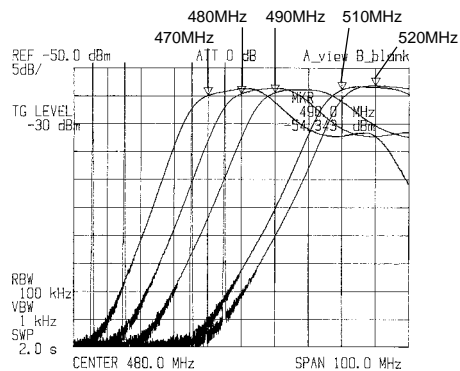

Band Pass Filter Characteristic (K3)

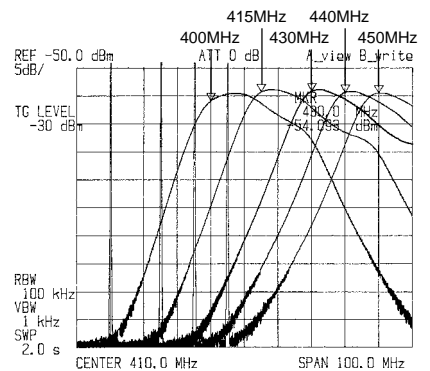

PC BOARD VIEW

TK-3140

TX-RX UNIT (X57-6410-XX) Component Side View (J72-0807-19)
-10:TK-3140 K, -11:TK-3140 K2, -12:TK-3140 K3

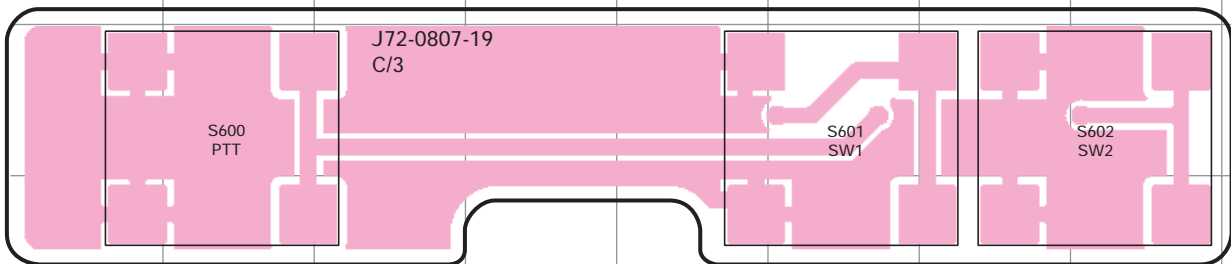
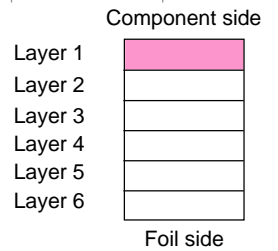
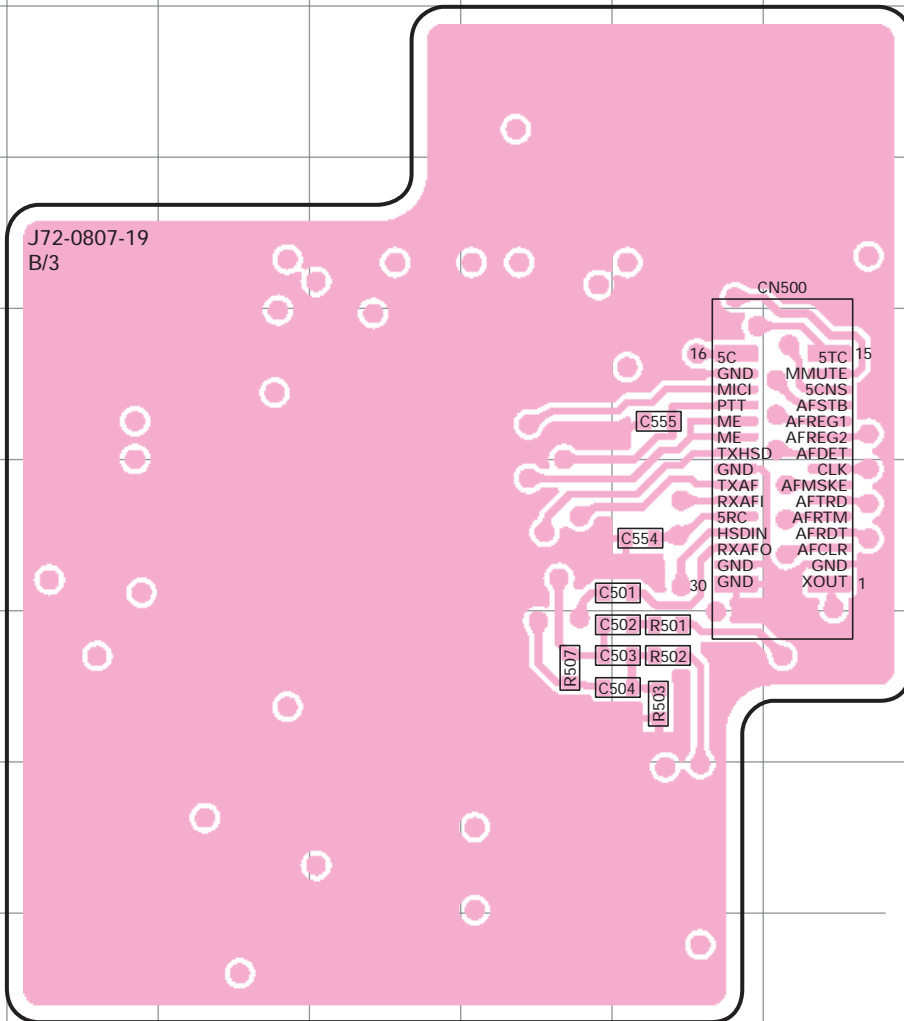

TK-3140

PC BOARD VIEW

TX-RX UNIT (X57-6410-XX) Foil Side View (J72-0807-19)
 -10:TK-3140 K, -11:TK-3140 K2, -12:TK-3140 K3

TX-RX UNIT
 (X57-6410-XX)

Ref. No.	Address
IC500	6F
IC501	9G
Q500	8D
Q501	6H
Q502	8G
D501	8H

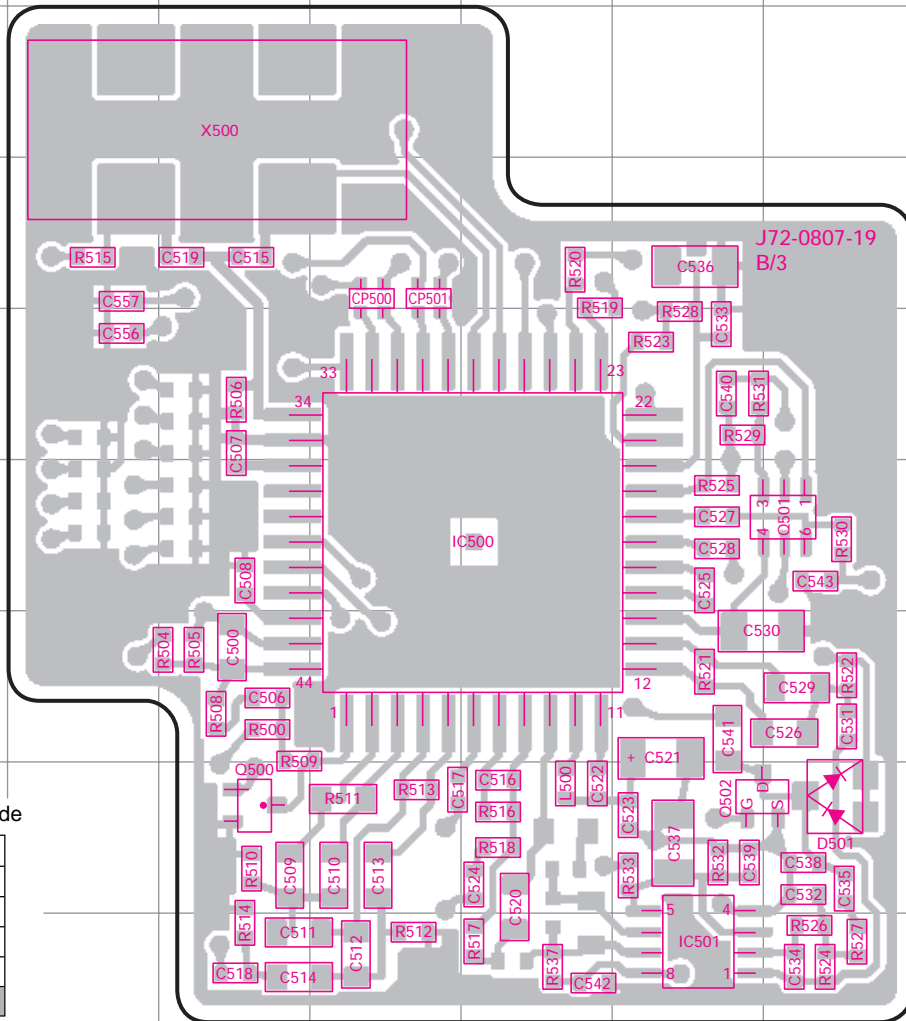

Component side

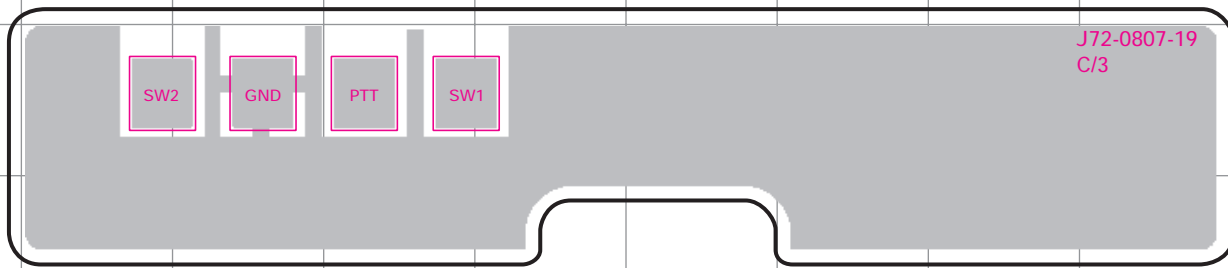
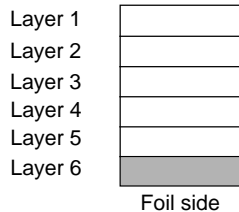

DTC144EE



2SK1830



UPA672T

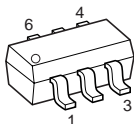

TC35453F

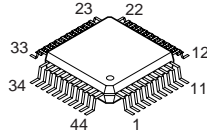

TC75W51FU

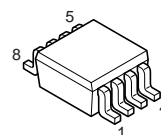

PC BOARD VIEW

TK-3140

TX-RX UNIT (X57-6410-XX) Component Side View + Foil Side View (J72-0807-19)
 -10:TK-3140 K, -11:TK-3140 K2, -12:TK-3140 K3

TX-RX UNIT
 (X57-6410-XX)

Ref. No.	Address
IC500	5I
IC501	8H
Q500	7K
Q501	5G
Q502	7H
D501	7G

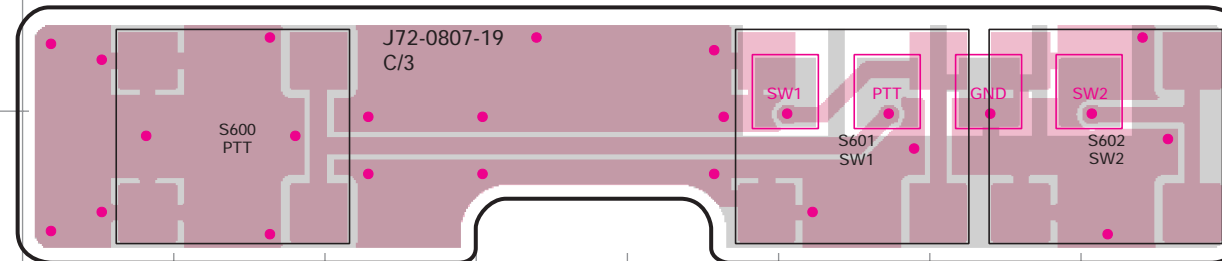
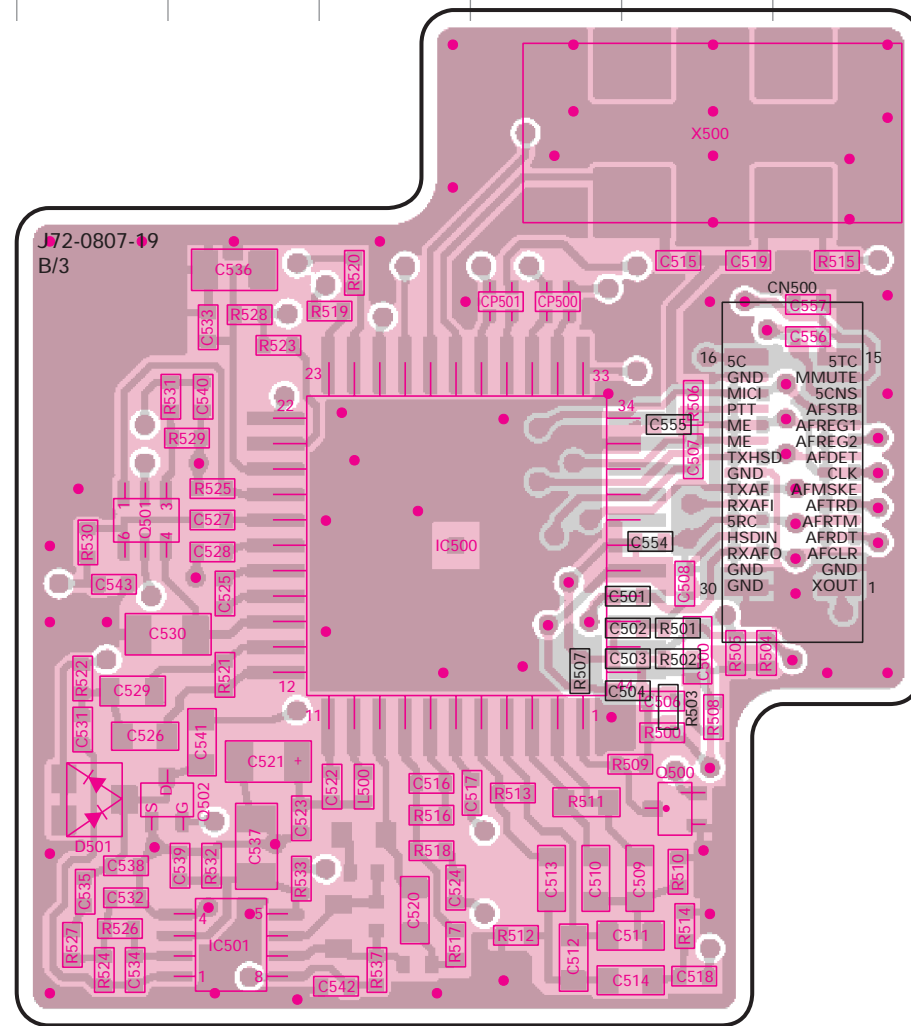

DTC144EE

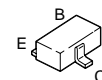

2SK1830

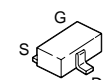

UPA672T

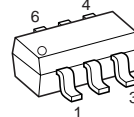

TC35453F

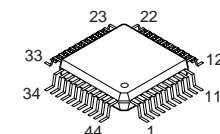

TC75W51FU

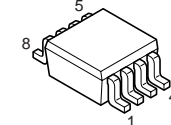

● Connect 1 and 6.

Component side

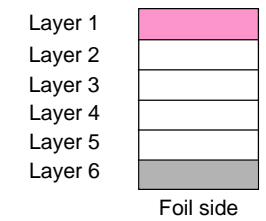

TK-3140

PC BOARD VIEW

TX-RX UNIT (X57-6410-XX) (A/3) Component Side View (J72-0807-19)
 -10:TK-3140 K, -11:TK-3140 K2, -12:TK-3140 K3

TA75W01FU
TC75W51FU

TDA7053AT

30620M8A-2N3GP

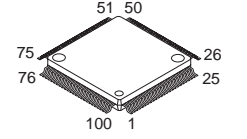
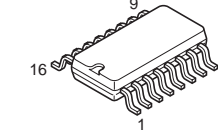
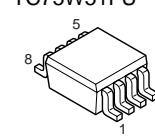

TX-RX UNIT (A/3)
(X57-6410-XX)

Ref. No.	Address
IC100	7H
IC302	8M
IC303	4M
IC308	5O
IC309	7O
IC310	10P
IC311	3N
IC312	3P
IC313	4F
IC400	5I
IC401	6E
IC402	10F
IC403	6H
Q104	8I
Q105	7I
Q107	7I
Q108	6H
Q300	10N
Q301	5I
Q302	6G
Q303	6F
Q304	10K
Q305	4I
Q306	10E
Q307	4H
Q308	4E
Q309	9E
Q310	9L
Q311	9L
Q400	6E
Q401	5I
Q403	10F
Q404	10F
Q405	9G
Q406	6H
D106	7I
D301	7F
D302	3J
D303	4I
D304	5L
D305	6G
D306	4J
D307	5H
D308	4I
D402	10E
D405	7E

DTA144EE
DTC114EE
DTC144EE
2SA1362(Y)
2SC4617(S)

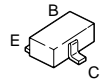

2SB1132(Q,R)

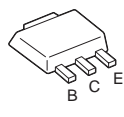

2SC4649(N,P)

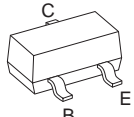

DA221

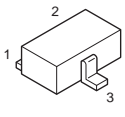

2SJ347
2SK1830



UPA672T

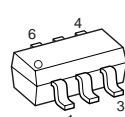

2SK1824

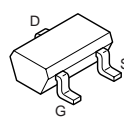

XC6204B502MR

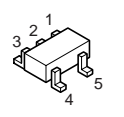

W29C020C90

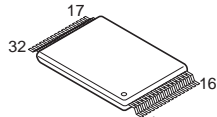

AT2416N10SI2.5

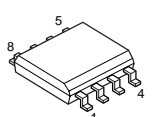

XC62GR5012PR

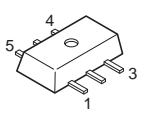

AT29C020-90T1

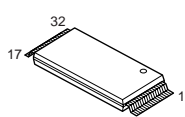

BU4094BCFV

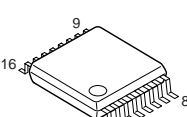

Component side

Layer 1
Layer 2
Layer 3
Layer 4
Layer 5
Layer 6

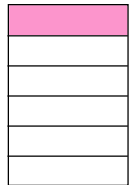

Foil side

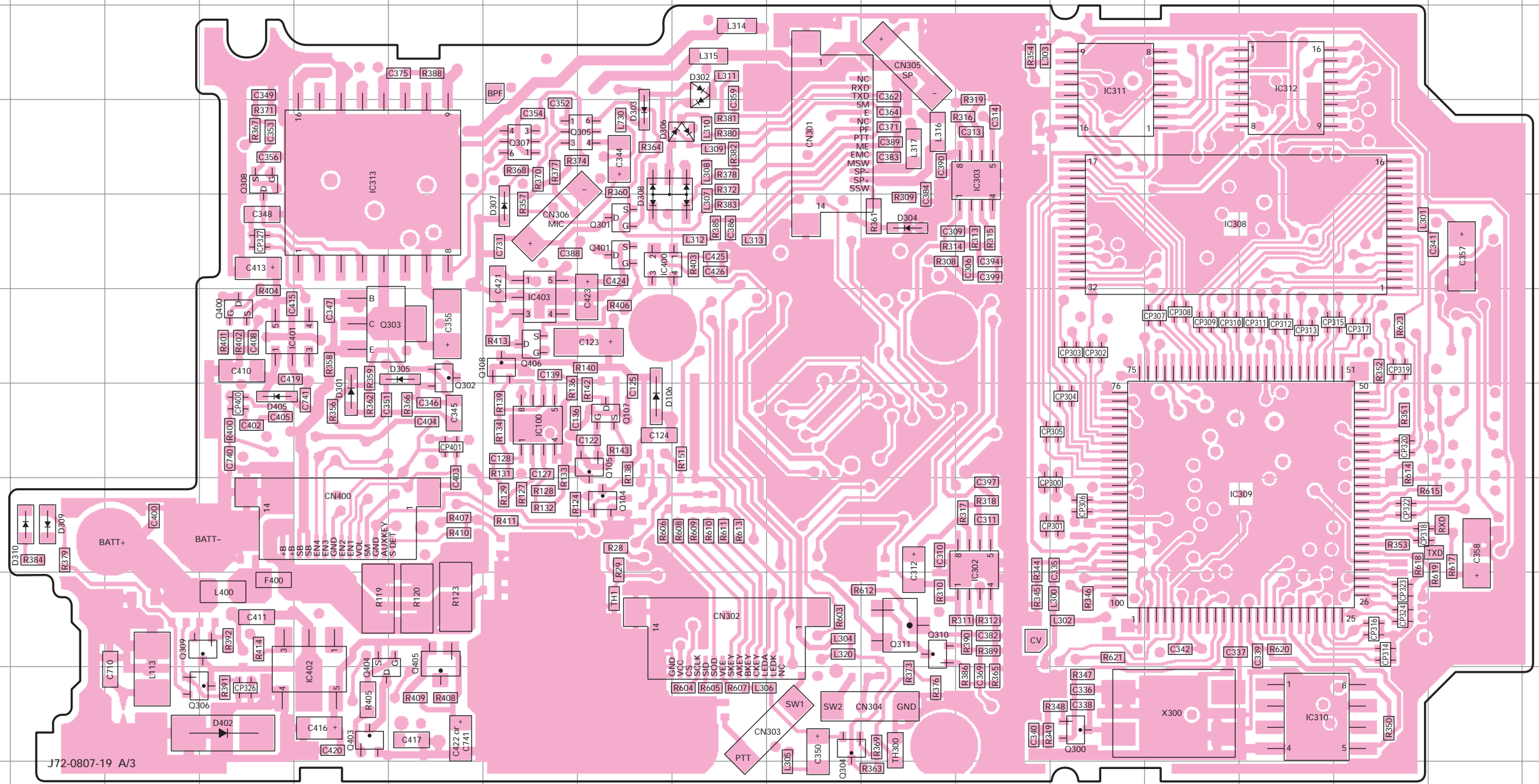

J72-0807-19 A/3

PC BOARD VIEW

TK-3140

TX-RX UNIT (X57-6410-XX) (A/3) Foil Side View (J72-0807-19)
 -10:TK-3140 K, -11:TK-3140 K2, -12:TK-3140 K3

TX-RX UNIT (A/3)
 (X57-6410-XX)

Ref. No.	Address
IC1	8F
IC200	4H
IC201	6E
IC300	7D
IC301	9C
IC304	8E
IC305	5C
IC306	10E
IC307	4D
IC404	7O
Q1	7G
Q2	9I
Q3	8I
Q4	9J
Q5	8J
Q6	9J
Q7	10J
Q8	7J
Q100	6L
Q101	6L
Q103	7K
Q106	10L
Q201	5D
Q202	5I
Q203	5G
Q204	5H
Q205	4I
Q206	4L
Q207	6N
Q208	6D
D1	7H
D2	10I
D3	7H
D4	10H
D5	7I
D6	9J
D7	8H
D8	7H
D9	10I
D10	10H
D100	5J
D101	5K
D102	9N
D103	9O
D104	9O
D105	8O
D200	8D
D201	7E
D202	5E
D203	5E
D204	4N
D205	5N
D206	5M
D207	7M
D208	8M
D209	5G
D300	7D
D403	6O

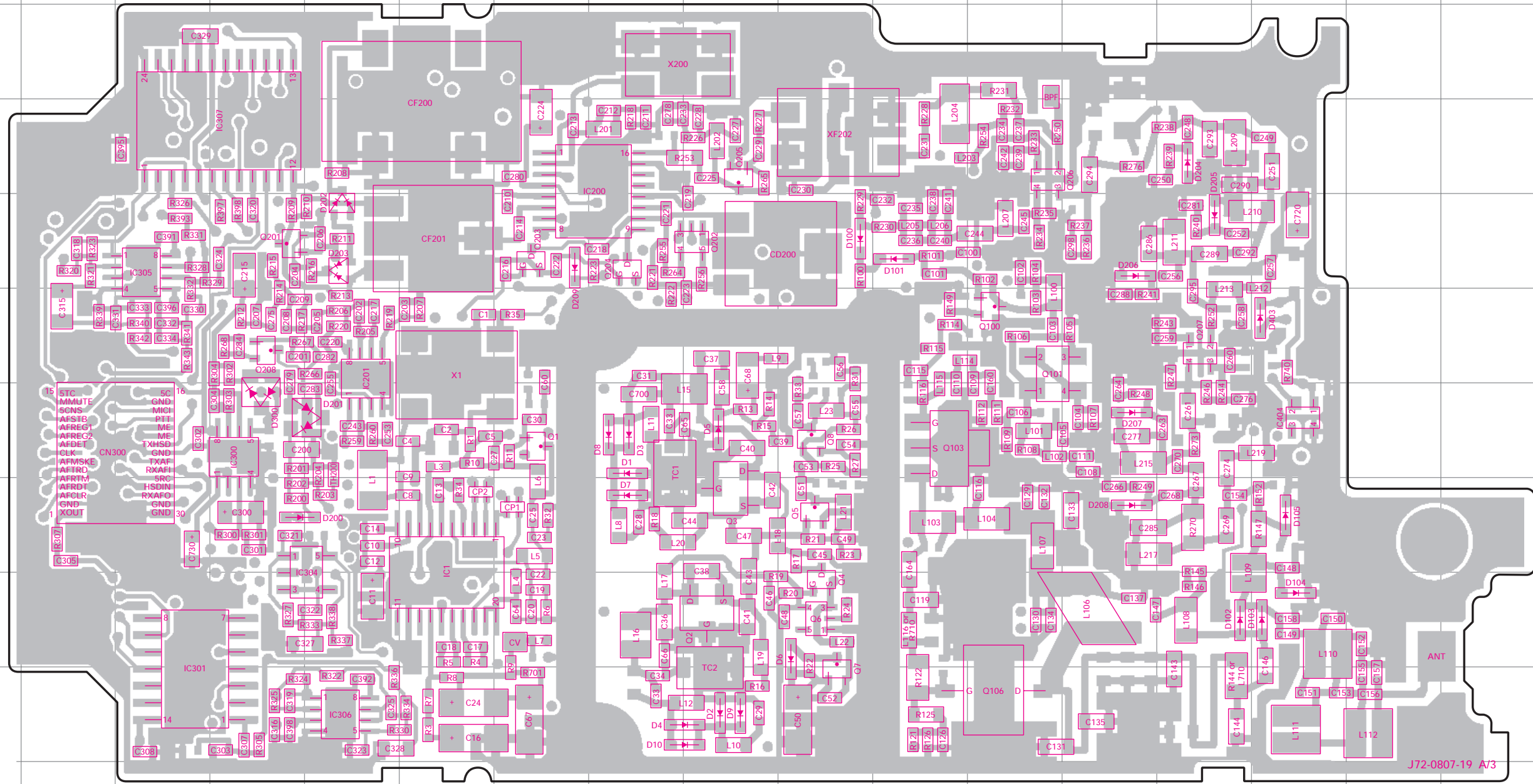

DTC144EE
 2SC4617(S)
 2SC5108(Y)

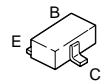

2SC5192

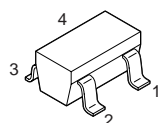

2SC4649(N,P)

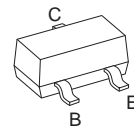

RN47A4

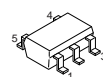

2SK508NV(K52)



2SJ347
 2SK1830

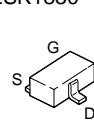

2SK2596

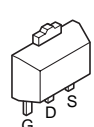

2SK1824

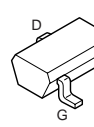

TC75S51F

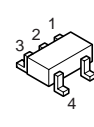

SA7025DK

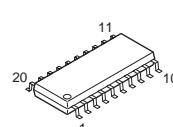

M62364FP

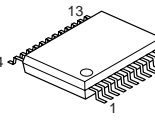

TC75W51FU

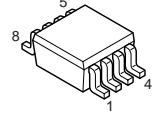

TA31136FN

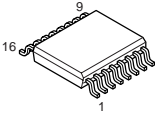

LC73872M

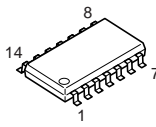

XC61CN5002NR

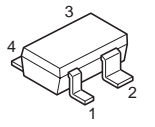

2SK3476

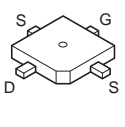

Component side

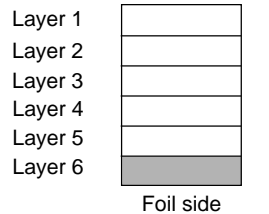

TK-3140

PC BOARD VIEW

TX-RX UNIT (X57-6410-XX) (A/3) Component Side View + Foil Side View (J72-0807-19)
 -10:TK-3140 K, -11:TK-3140 K2, -12:TK-3140 K3

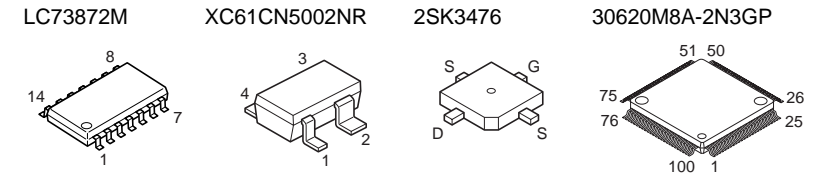

TX-RX UNIT (A/3)
 (X57-6410-XX)

Ref. No.	Address	Ref. No.	Address
IC1	8N	D8	6L
IC100	7H	D9	10K
IC200	4L	D10	10L
IC201	6O	D100	5J
IC300	7P	D101	5I
IC301	9Q	D102	9F
IC302	8M	D103	9F
IC303	4M	D104	9E
IC304	8O	D105	8E
IC305	5Q	D106	7I
IC306	10O	D200	8P
IC307	4P	D201	7O
IC308	5O	D202	5O
IC309	7O	D203	5O
IC310	10P	D204	4F
IC311	3N	D205	5F
IC312	3P	D206	5G
IC313	4F	D207	7G
IC400	5I	D208	8G
IC401	6E	D209	5M
IC402	10F	D300	7P
IC403	6H	D301	7F
IC404	7F	D302	3J
Q1	7M	D303	4I
Q2	9K	D304	5L
Q3	8K	D305	6G
Q4	9J	D306	4J
Q5	8J	D307	5H
Q6	9J	D308	4I
Q7	10J	D402	10E
Q8	7J	D403	6E
Q100	7H	D405	7E
Q101	6H		
Q103	7I		
Q104	8I		
Q105	7I		
Q106	10H		
Q107	7I		
Q108	6H		
Q201	5P		
Q202	5K		
Q203	5M		
Q204	5L		
Q205	4K		
Q206	4H		
Q207	6F		
Q208	6P		
Q300	10N		
Q301	5I		
Q302	6G		
Q303	6F		
Q304	10K		
Q305	4I		
Q306	10E		
Q307	4H		
Q308	4E		
Q309	9E		
Q310	9L		
Q311	9L		
Q400	6E		
Q401	5I		
Q403	10F		
Q404	10F		
Q405	9G		
Q406	6H		
D1	7L		
D2	10K		
D3	7L		
D4	10L		
D5	7K		
D6	9J		
D7	8L		

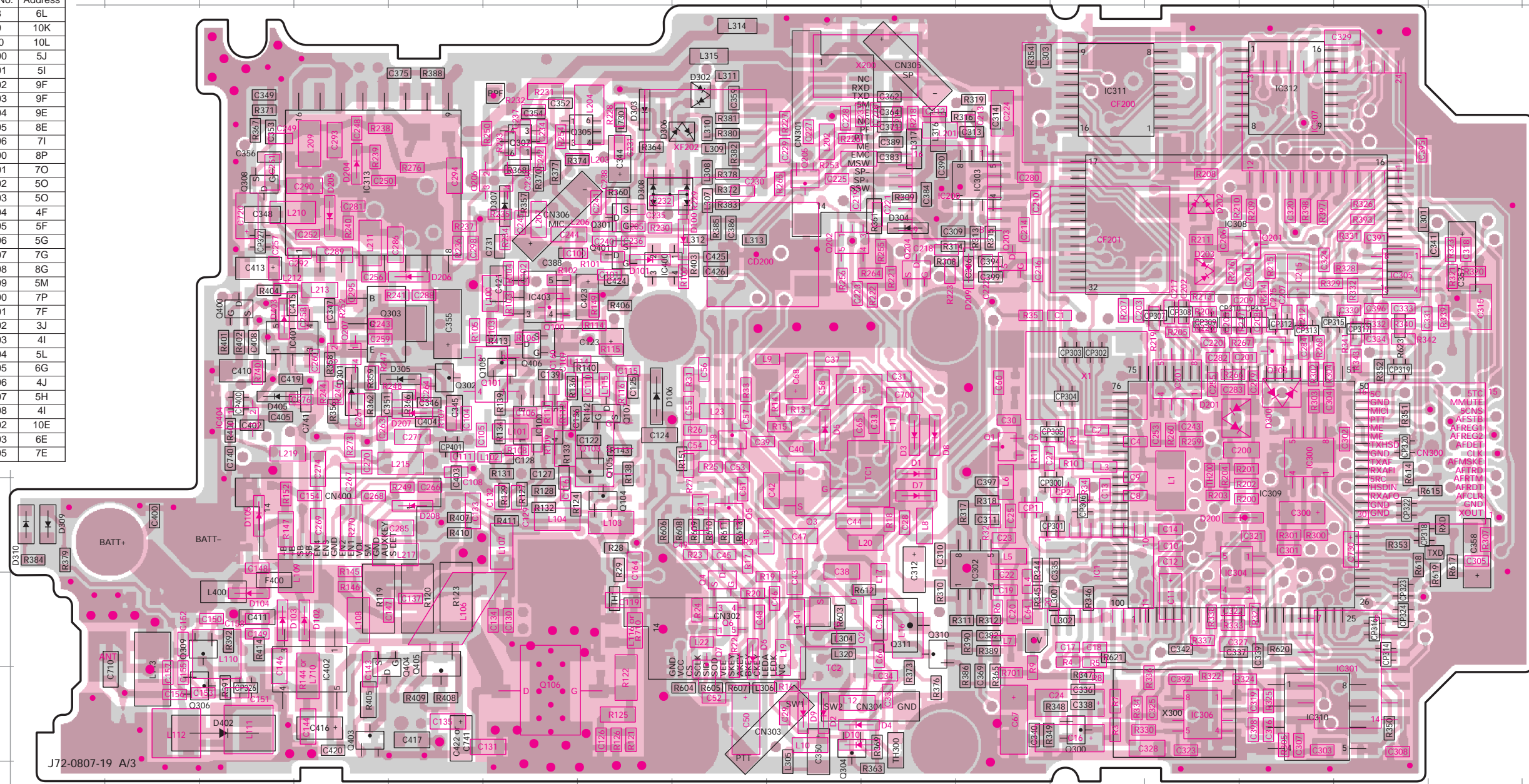

DTA144EE	2SB1132(Q,R)	2SC5192	2SC4649(N,P)	RN47A4	DA221	2SK508NV(K52)	2SJ347 2SK1830	2SK2596	UPA672T	2SK1824	TC75S51F XC6204B502MR
DTC144EE											
2SA1362(Y)											
2SC4617(S)											
2SC5108(Y)											
	W29C020C90	AT2416N10SI2.5	XC62GR5012PR	AT29C020-90TI	SA7025DK	BU4094BCFV	M62364FP	TA75W01FU TC75W51FU	TDA7053AT	TA31136FN	

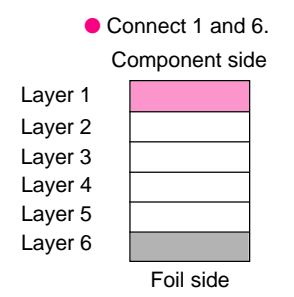

TK-3140 TK-3140

BLOCKDIAGRAM

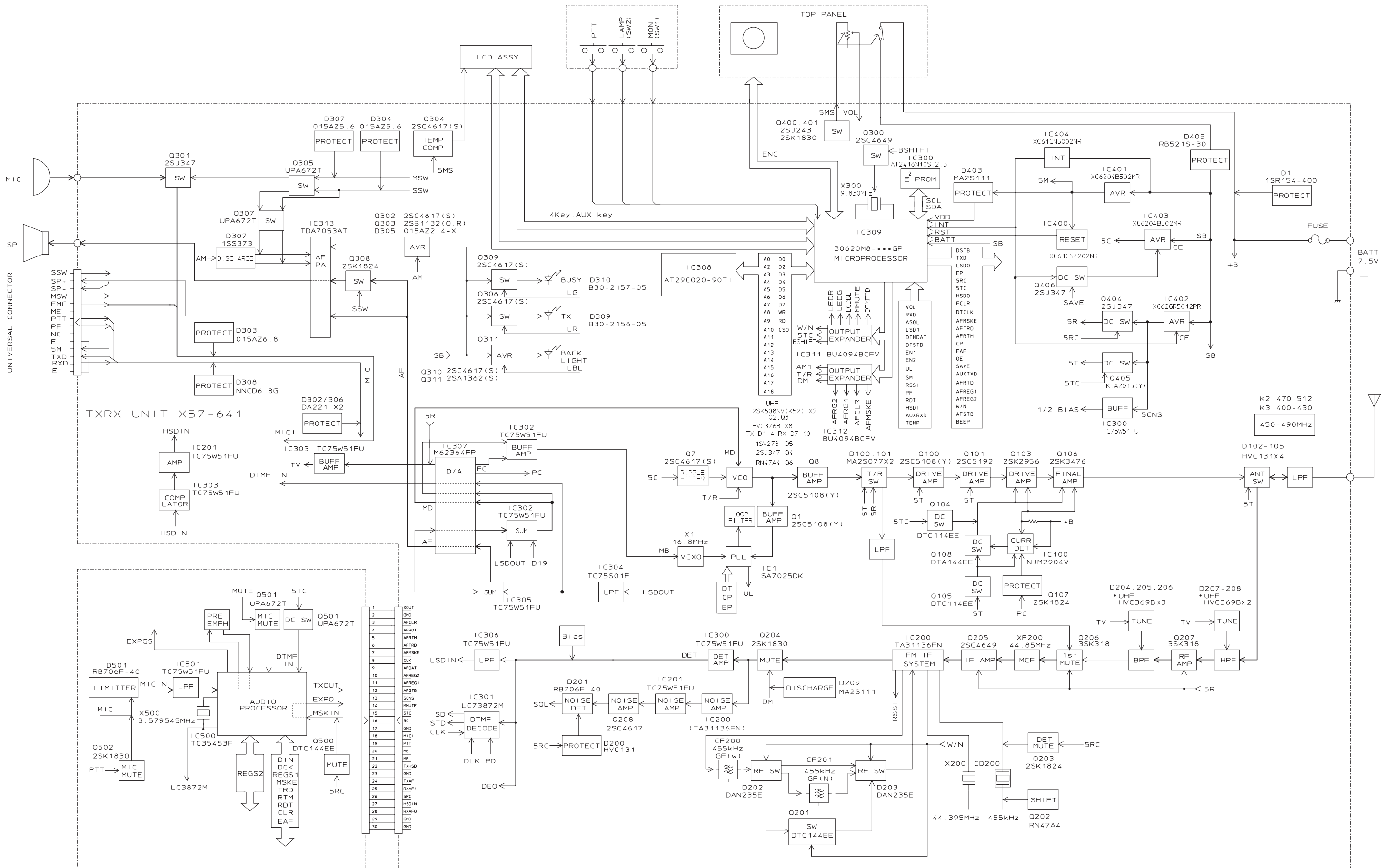

LEVEL DIAGRAM

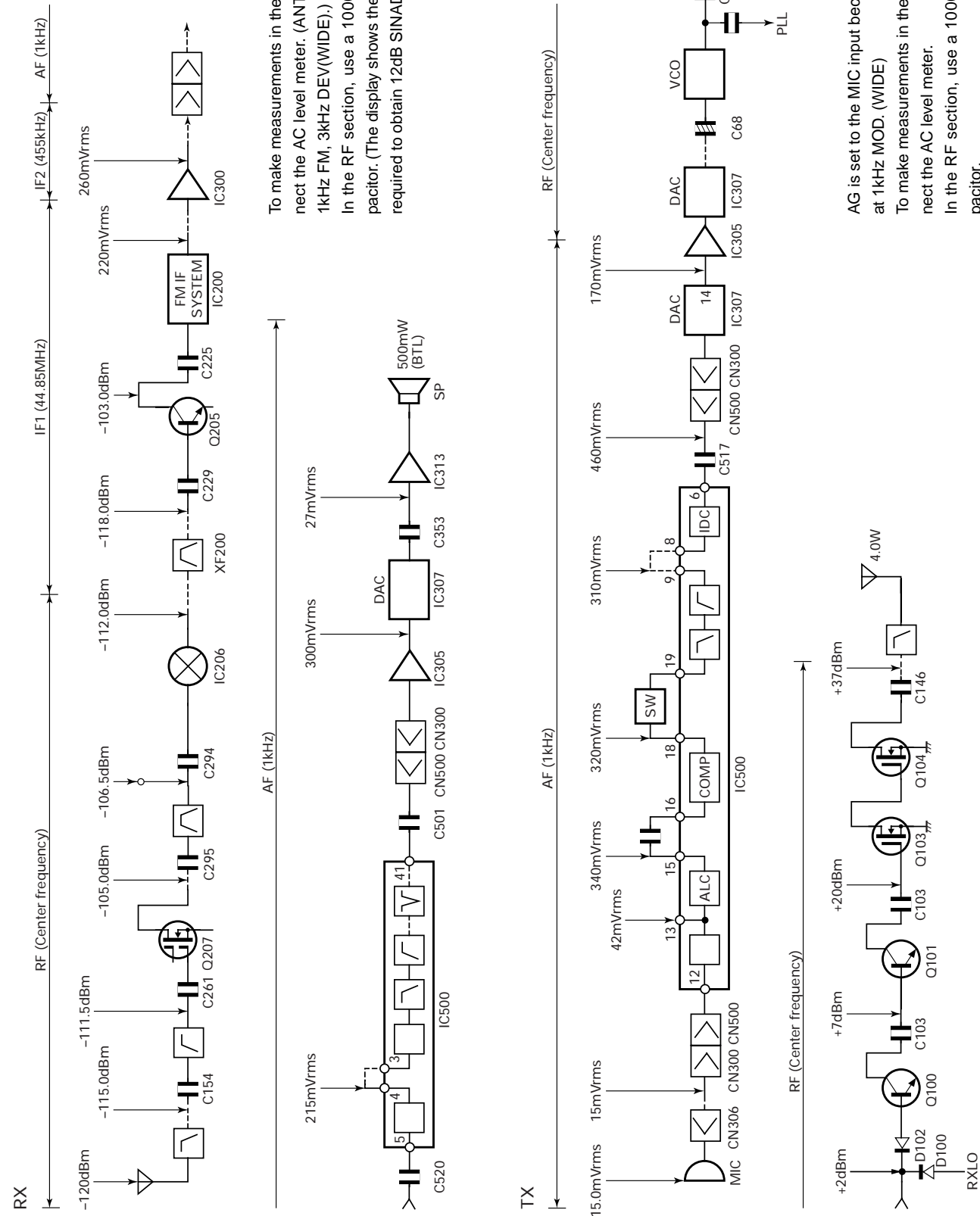

KBP-5 BATTERY CASE



AA alkaline battery x 6

KRA-23 UHF Helical Antenna



- M : 440-490MHz
- M2 : 470-520MHz
- M3 : 400-450MHz

SPECIFICATIONS

General

Frequency Range	
RX, TX	K : 450 to 490MHz K2 : 470 to 512MHz K3 : 400 to 430MHz
Systems	Trunked Mode : Maximum 32
Groups	Maximum 250
Channels	Trunked Mode : Maximum 600 Conventional Mode : Maximum 250
Channel Spacing (Wide/Narrow)	25/12.5kHz
PLL Channel Stepping	5.0, 6.25kHz
Operating Voltage	DC 7.5V \pm 20%
Battery Life	About 9 hours at 5-5-90 duty cycle with KNB-24L battery About 8 hours at 5-5-90 duty cycle with KNB-25A battery About 12 hours at 5-5-90 duty cycle with KNB-26N battery
Temperature Range	-30°C to +60°C (-22°F to + 140°F)
Dimension and Weight	
With KNB-24L (1400mAh battery)	4.13" (105mm) H x 2.21" (56mm) W x 1.16" (29.5mm) D x 0.66lbs (300g)

Receiver (Measurements made per TIA/EIA-603)

RF Input Impedance	50 Ω
Sensitivity	
12dB SINAD (Wide/Narrow)	0.25 μ V/0.28 μ V
Selectivity (Wide/Narrow)	70dB/65dB
Intermodulation (Wide/Narrow)	70dB/62dB
Spurious	70dB
Frequency Stability	\pm 0.00025% (-30°C to +60°C)
Channel Spread	K : 40MHz, K2 : 42MHz, K3 : 30MHz
Audio Power Output	500mW at 16 Ω less than 5% distortion

Transmitter (Measurements made per TIA/EIA-603)

RF Power Output	
Hi	4W
Low	1W
RF Output Impedance	50 Ω
Spurious	70dB
Modulation (Wide/Narrow)	16K0F3E/11K0F3E
FM Noise (Wide/Narrow)	45dB/40dB
Audio Distortion	Less than 3%
Frequency Stability	\pm 0.00025% (-30°C to +60°C)
Channel Spread	K : 40MHz, K2 : 42MHz, K3 : 30MHz

TK-3140

KENWOOD CORPORATION

14-6, Dogenzaka 1-chome, Shibuya-ku, Tokyo 150-8501, Japan

KENWOOD SERVICE CORPORATION

P.O. BOX 22745, 2201 East Dominguez Street, Long Beach, CA 90801-5745,
U.S.A.

KENWOOD ELECTRONICS CANADA INC.

6070 Kestrel Road, Mississauga, Ontario, Canada L5T 1S8

KENWOOD ELECTRONICS DEUTSCHLAND GMBH

Rembrücker Str. 15, 63150 Heusenstamm, Germany

KENWOOD ELECTRONICS BELGIUM N.V.

Leuvensesteenweg 248 J, 1800 Vilvoorde, Belgium

KENWOOD ELECTRONICS FRANCE S.A.

13, Boulevard Ney, 75018 Paris, France

KENWOOD ELECTRONICS U.K. LIMITED

KENWOOD House, Dwight Road, Watford, Herts., WD1 8EB United Kingdom

KENWOOD ELECTRONICS EUROPE B.V.

Amsterdamseweg 37, 1422 AC Uithoorn, The Netherlands

KENWOOD ELECTRONICS ITALIA S.p.A.

Via G. Sirtori, 7/9 20129 Milano, Italy

KENWOOD IBERICA S.A.

Bolivia, 239-08020 Barcelona, Spain

KENWOOD ELECTRONICS AUSTRALIA PTY. LTD.

(A.C.N. 001 499 074)

16 Giffnock Avenue, Centrecourt Estate, North Ryde, N.S.W. 2113, Australia

KENWOOD ELECTRONICS (HONG KONG) LTD.

Unit 3712-3724, Level 37, Tower one Metroplaza, 223 Hing Fong Road, Kwai Fong, N.T.,
Hong Kong

KENWOOD ELECTRONICS TECHNOLOGIES(S) PTE LTD.

Sales Marketing Division

1 Ang Mo Kio Street 63, Singapore 569110

